

Modernizing Accelerator Control System Towards CSNS-II

Yuliang Zhang

2025.03.10

China Spallation Neutron Source

Institute of High Energy Physics



- I. Brief Introduction of CSNS and CSNS-II**
- II. Present Status of Accelerator Control System**
- III. Upgrade of Accelerator Control System**
- IV. Summary**





CSNS Bird's Eye View



CSNS Facility

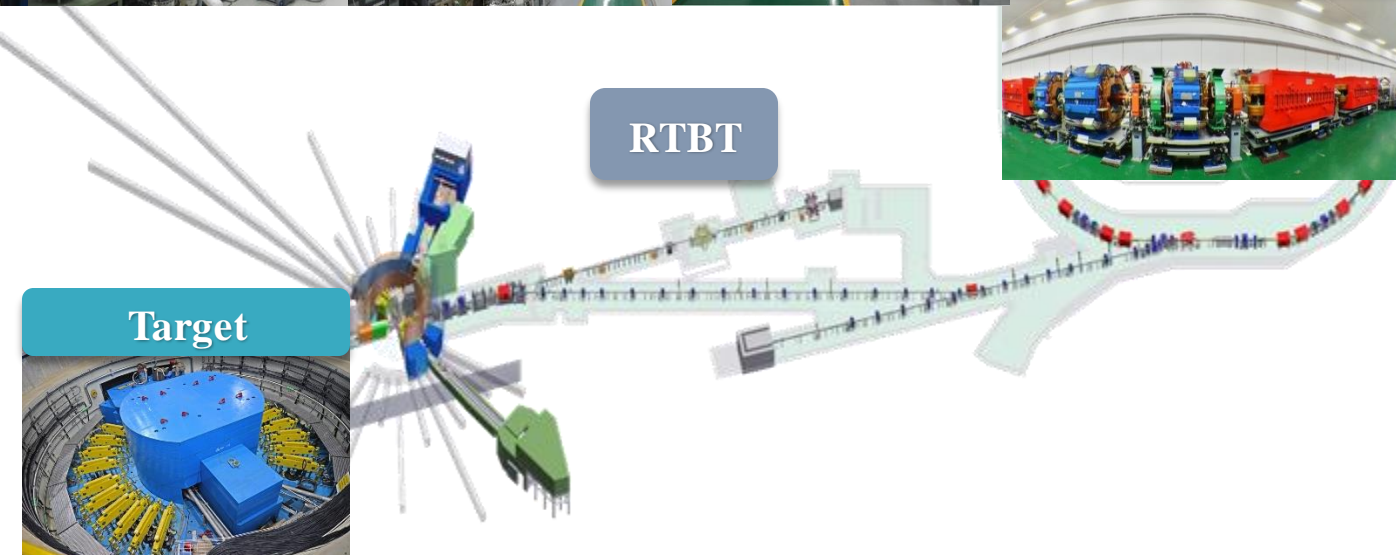
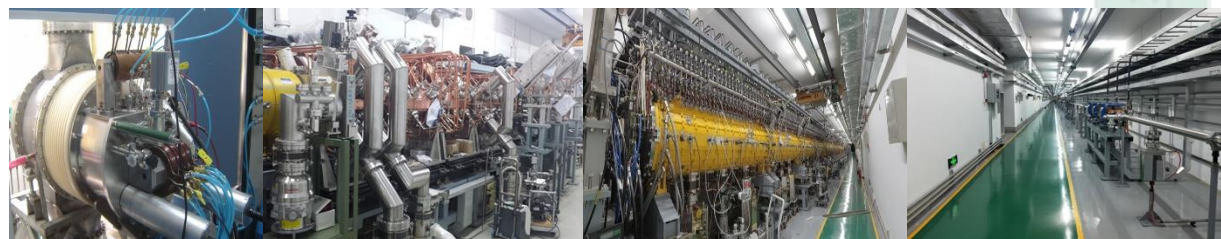
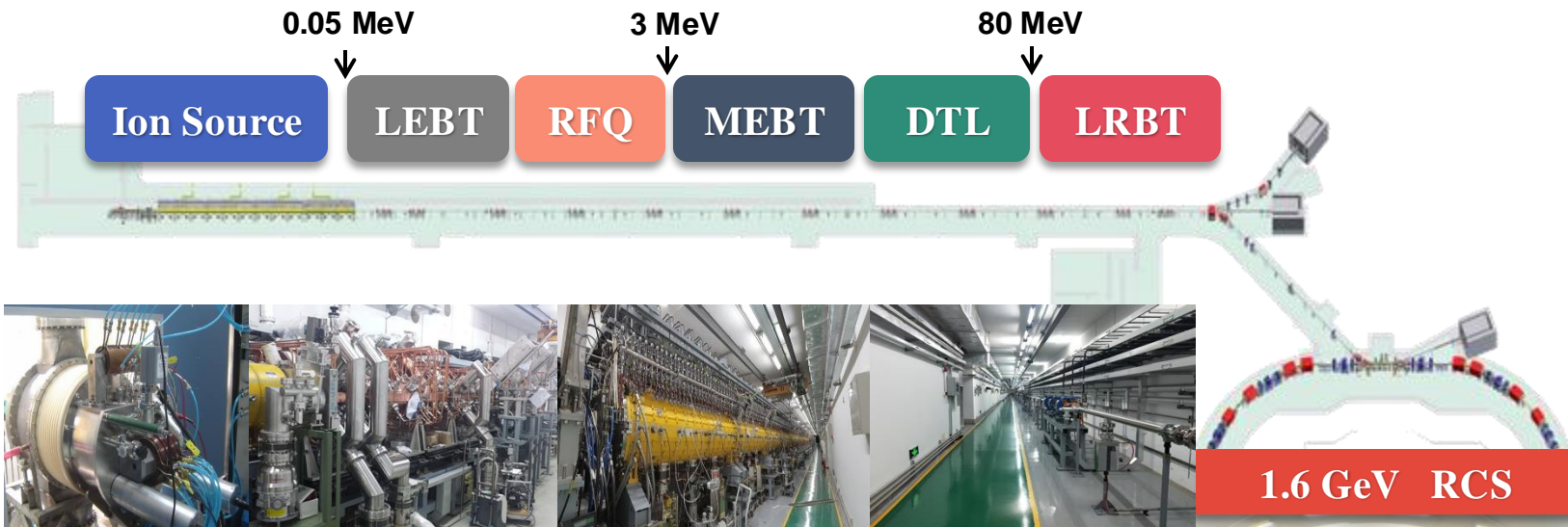
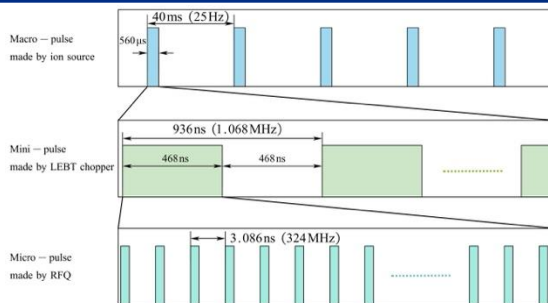

Beam Power on target [kW]	100
Proton energy [GeV]	1.6
Average beam current [uA]	62.5
Pulse repetition rate [Hz]	25
Linac energy [MeV]	80
Linac type	NC
Linac RF frequency [MHz]	324
Macropulse duty factor	1.05
RCS circumference [m]	228
RCS harmonic number	2
Target	1
Spectrometers	3

CSNS Beam Power history

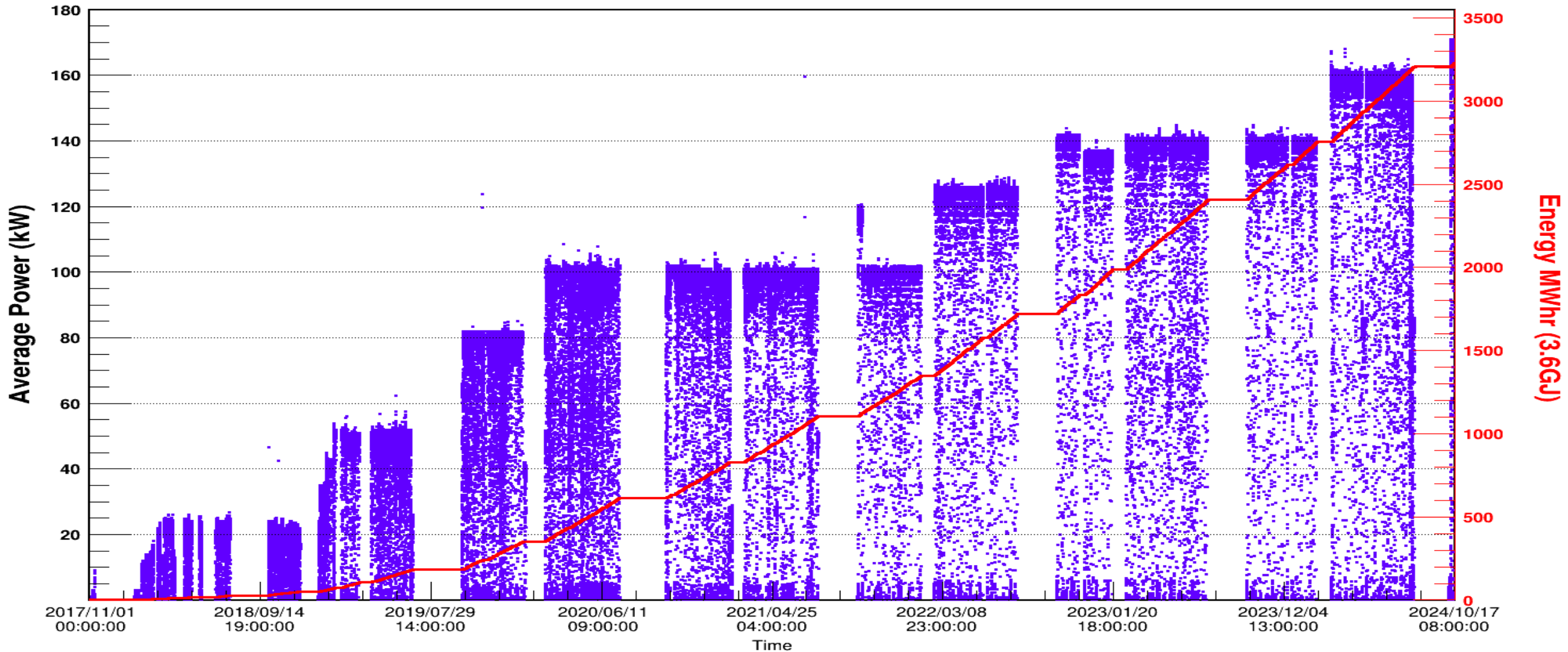

10kW **20kW** **50kW** **80kW** **100kW** **125kW** **140kW** **160kW** **170kW**
Nov. 2017 **Mar. 2018** **Jan. 2019** **Sep. 2019** **Feb. 2020** **Feb. 2022** **Oct. 2022** **Mar. 2024** **Oct. 2024**

Downtime Statistics



- Downtime statistics in hours by system during user experiments over the past 6 years

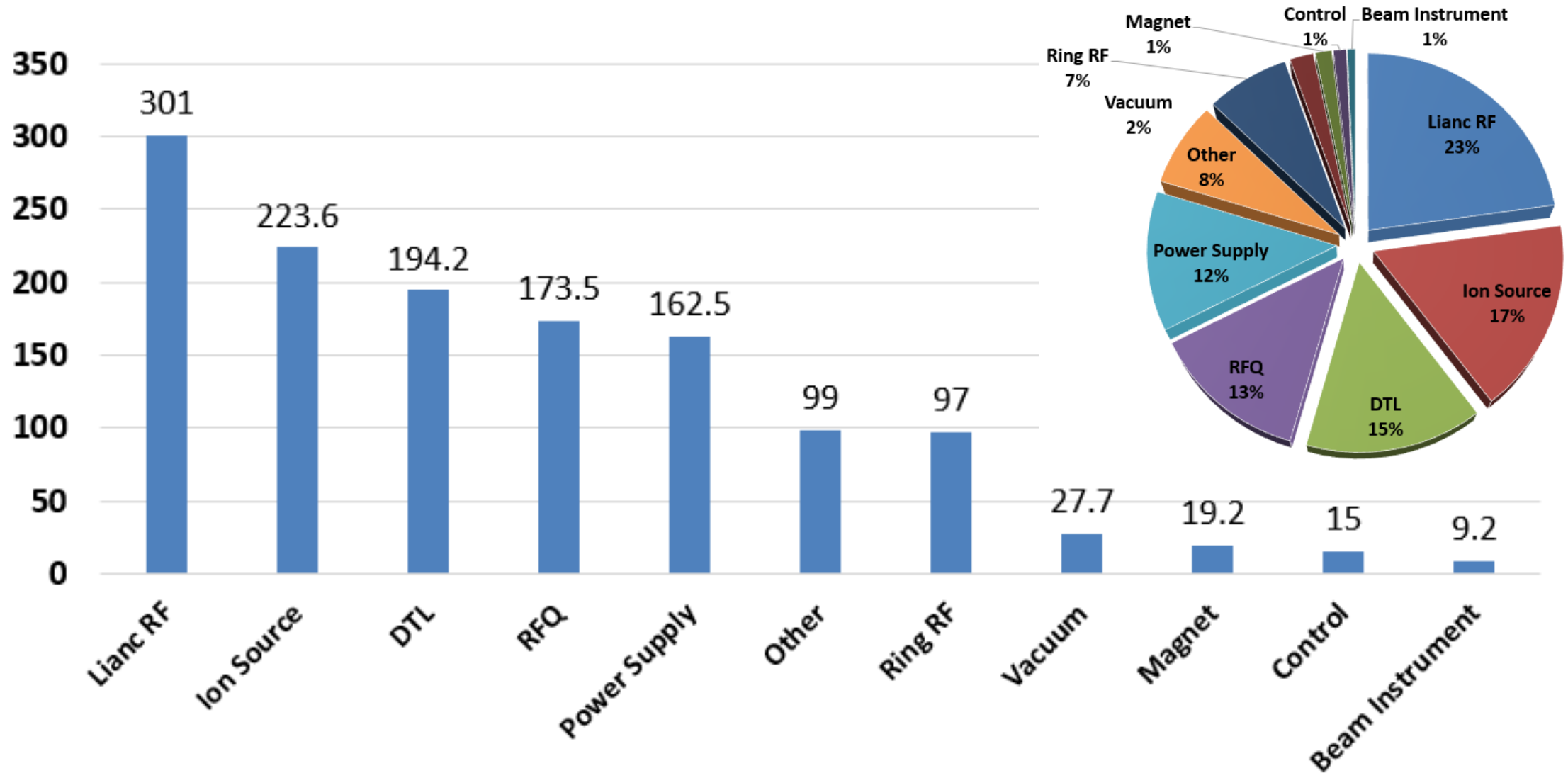

Accelerator performance

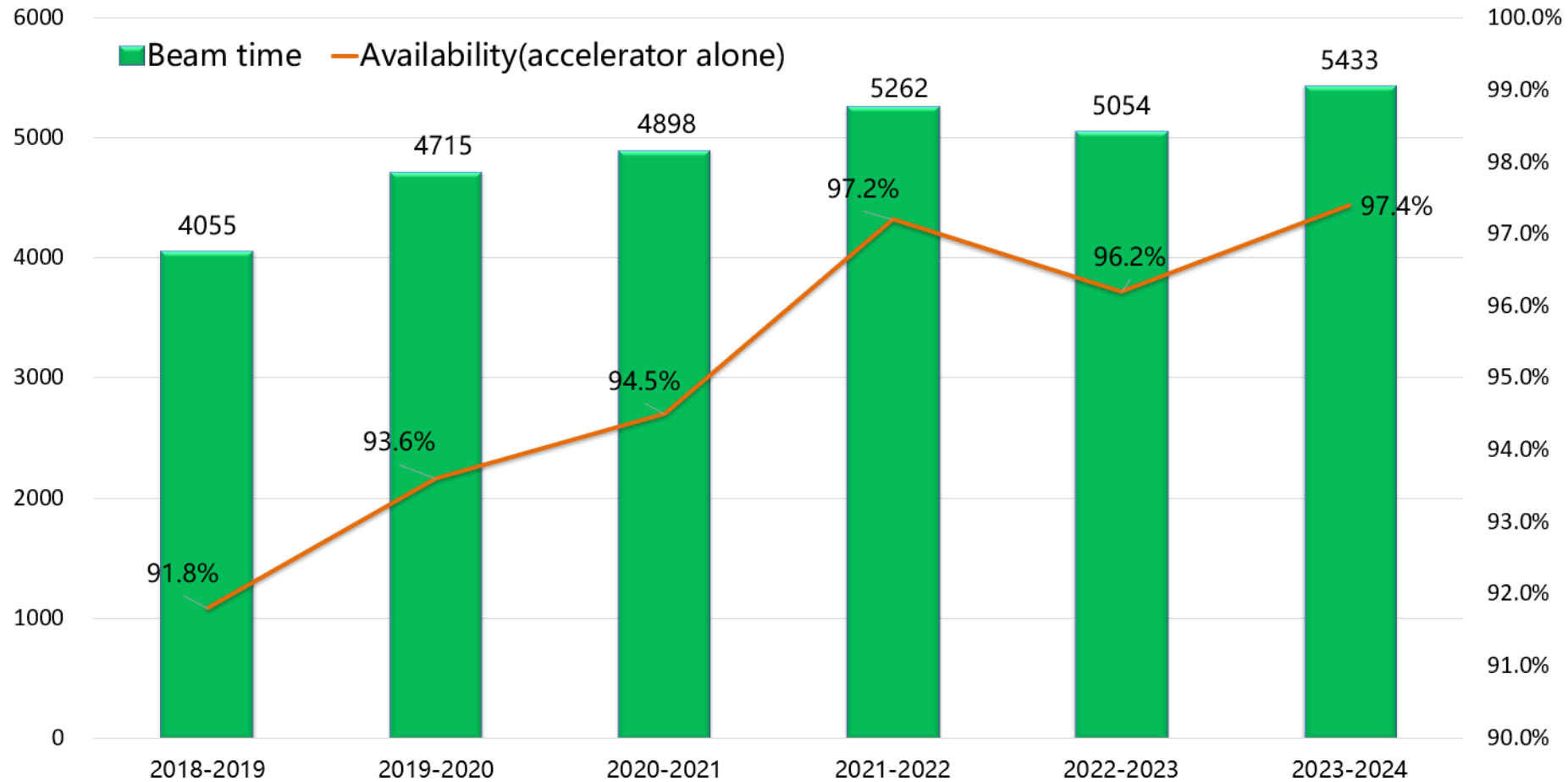

- The accelerator routinely operates with >95% availability in recent years
- From October 2023 to July 2024, the beam availability has been improved to **97.4%**.

Scope of the CSNS-II

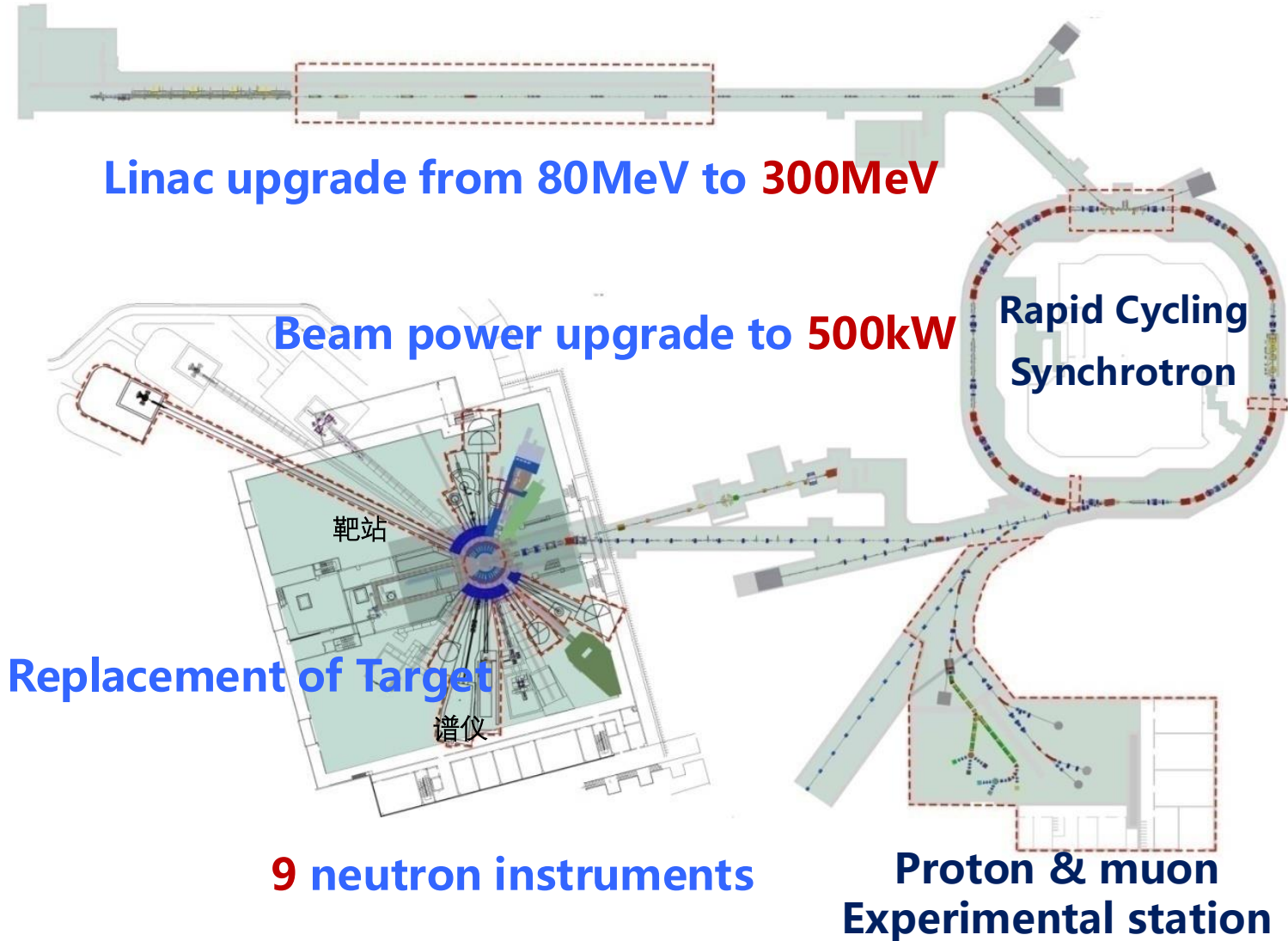

Linac upgrade from 80MeV to 300MeV

Beam power upgrade to 500kW

Rapid Cycling Synchrotron

Replacement of Target

9 neutron instruments

Proton & muon Experimental station

	CSNS	CSNS-II
Beam Power on target [kW]	100	500
Proton energy [GeV]	1.6	1.6
Average beam current [uA]	62.5	312
Pulse repetition rate [Hz]	25	50
Linac energy [MeV]	80	300
Linac type	RT	RT+SC
Linac RF frequency [MHz]	324	324/648
Spectrometers	3	11+8

Beam Power Upgrade (two-steps)



- 1. Linac (80MeV) + RCS upgrade 200kW (the first step)**
 - ✓ New dual harmonic RF system
 - ✓ Adding AC trim quadrupoles, sextupoles and octupoles
 - ✓ New injection region
- 2. Linac (300MeV+) + upgraded RCS 500kW (the second step)**
 - ✓ SC linac to 300MeV
 - ✓ Upgrade the power supplies for main magnets



I. Brief Introduction of CSNS and CSNS-II

II. Present Status of Accelerator Control System

III. Upgrade of Accelerator Control System

IV. Summary

Accelerator Control System Status



- EPICS based large distributed control system
- Standard three layers architecture system

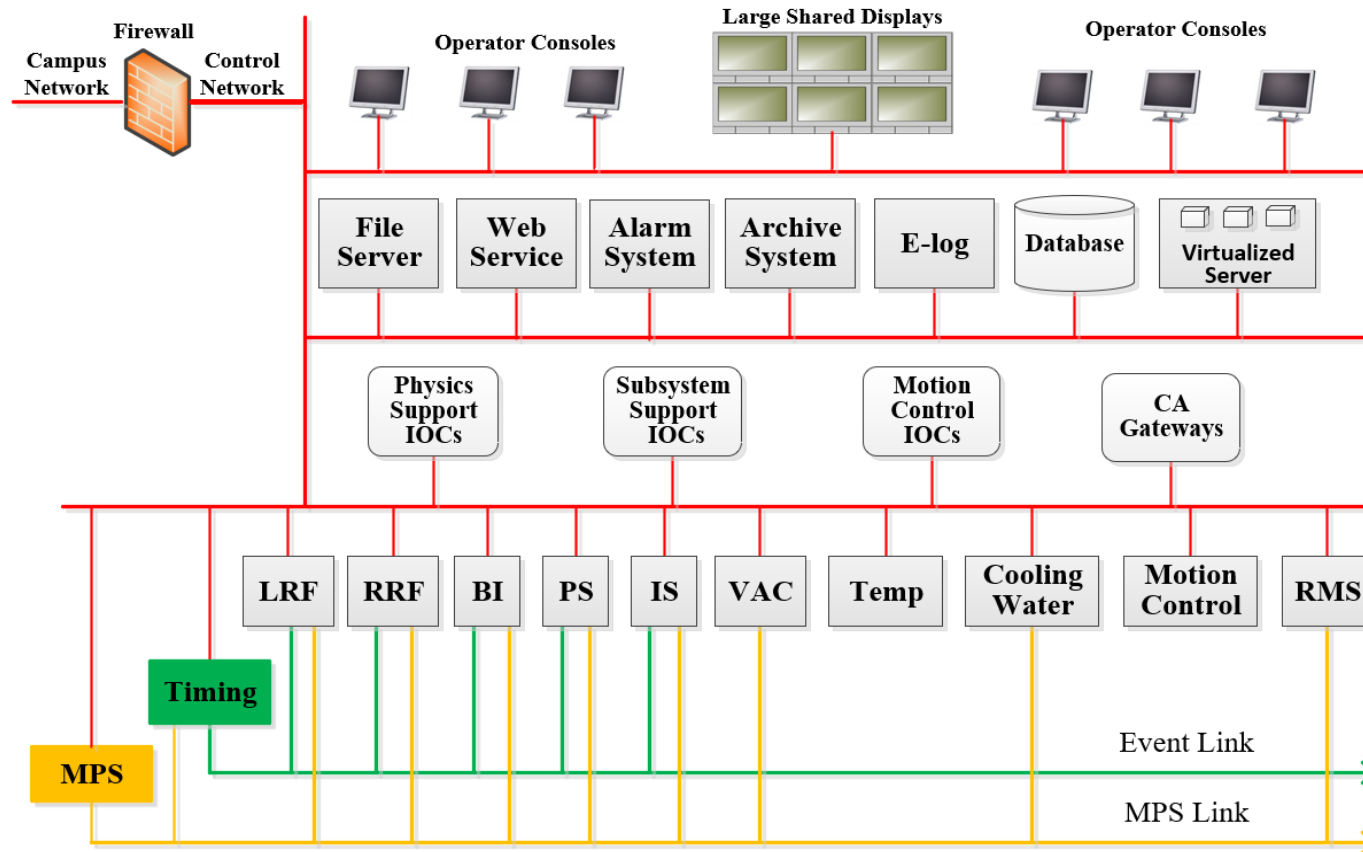

Accelerator Control System Scope



- **Global systems**
 - Timing system
 - Machine protection system
 - Control Network
 - Servers and Virtualization platform
- **High level applications**
 - Database
 - Services
 - High level applications
 - Desktop application
 - Web application
- **Low level & remote controls**
 - Vacuum/Power Supply/RF
 - IS/Front End/DTL
 - Inj. & Ext. PS
 - Strip Foil/Collimator
 - **Back-n(white neutron source)**
 - **APEP**
- **Conventional facility integration**
 - UPS/Isolated transformer
 - Cables/fibers/racks
 - Control rooms

Control System Software Fact



- Both open source and commercial software were adopted

- EPICS Base3.14.12.5 and synApp5.6

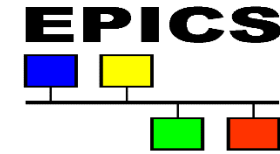

- CSS 3.2.16 and Phoebus CSS



- Archiver Tool

Archiver Appliance

- Redhat Linux 6.5



- VxWorks 5.5



- VMWare vSphere 7.0



Control System Hardware Fact



- Off the shelf and unified hardware for front-end control and IT infrastructure
 - Yokogawa & Inovance PLC
 - Moxa embedded industrial computer
 - 1G and 10G mixed network
 - VME platform
 - Blade server

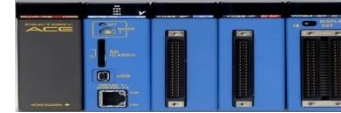

Control System Statistics



- **180 EPICS IOCs and 90K PVs**
- **The number of PVs will be more than 200K after CSNS-II**

	Number
Linux IOCs	130
Windows IOCs	30
VxWorks IOCs	22
PVs	≈90000
Archived PVs	35000
MPS Inputs	662
IPs	645

Operation of Control System



- The availability of control system is more than 99% except last year.
- Some aging issues with devices have started to appear.

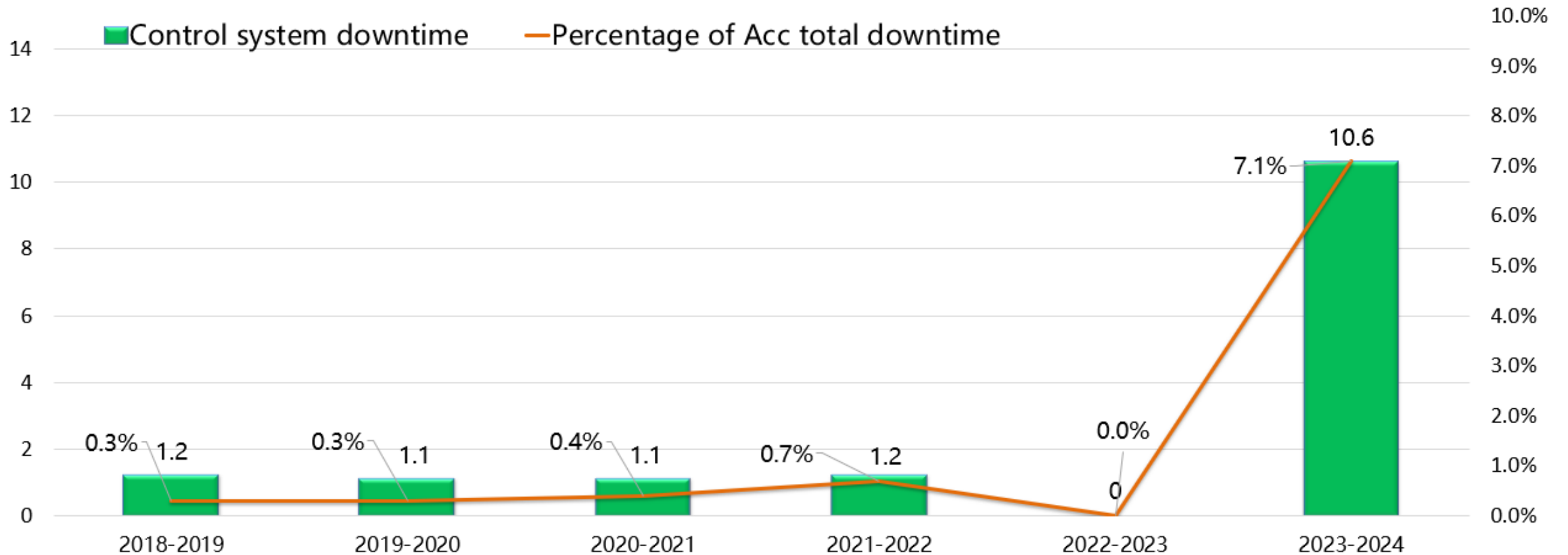



- I. Brief Introduction of CSNS and CSNS-II
- II. Present Status of Accelerator Control System
- III. Upgrade of Accelerator Control System**
- IV. Summary

Considerations of control system upgrading



- **No need for disruptive changes to the EPICS based architecture, it has proven reliable, extensible and sustainable.**
- **The hardware and software obsolescence issues must be addressed, and also keep a close eye on advanced technologies.**
- **The current control room tools are basic, improvement and replacement are needed.**
- **To provide big data and artificial intelligence resource should be considered.**
- **Challenges - No longer possible to have the control system down for an extended period so upgrades must be phased in during scheduled outages.**

Upgrade to EPICS 7



- Upgrade to EPICS 7, supporting PV Access and structured data type for big data
- Existing EPICS 3 systems peacefully co-exist with EPICS 4 systems

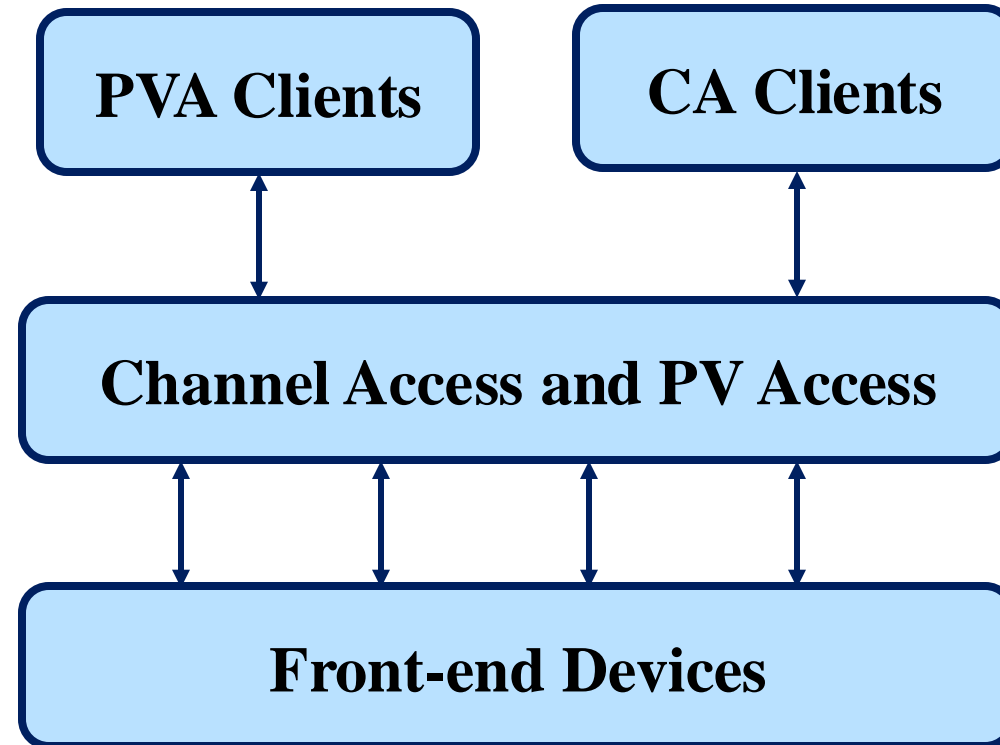

Convert VME to MTCA Platform



- **MTCA.4 platform** was determined as the fast control platform for timing system, LLRF, beam diagnostics
- **The domestic MTCA.4 hardware platform** has been developed and tested
 - **High performance specifications**
 - **Software and firmware with independent intellectual property rights**
 - **Lower costs and more flexible topology**

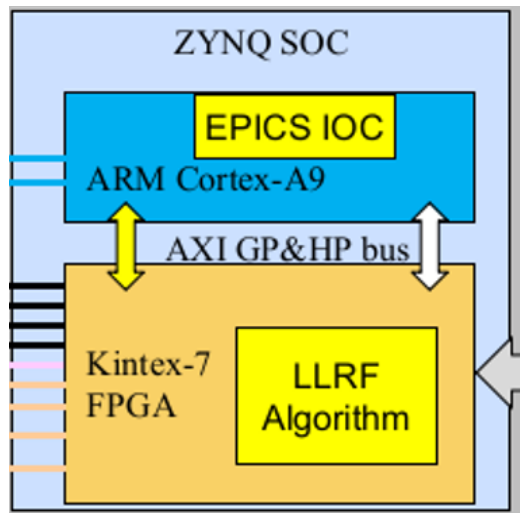

Accelerator Machine Protection System



- CSNS accelerator machine protection system consists of **PLC-based Normal MPS** and **FPGA based FPS**. Normal-MPS consists of two independent systems(NMPS-A and NMPS-B)
- Both NMPS and FPS use independent cable route to interlock beam.

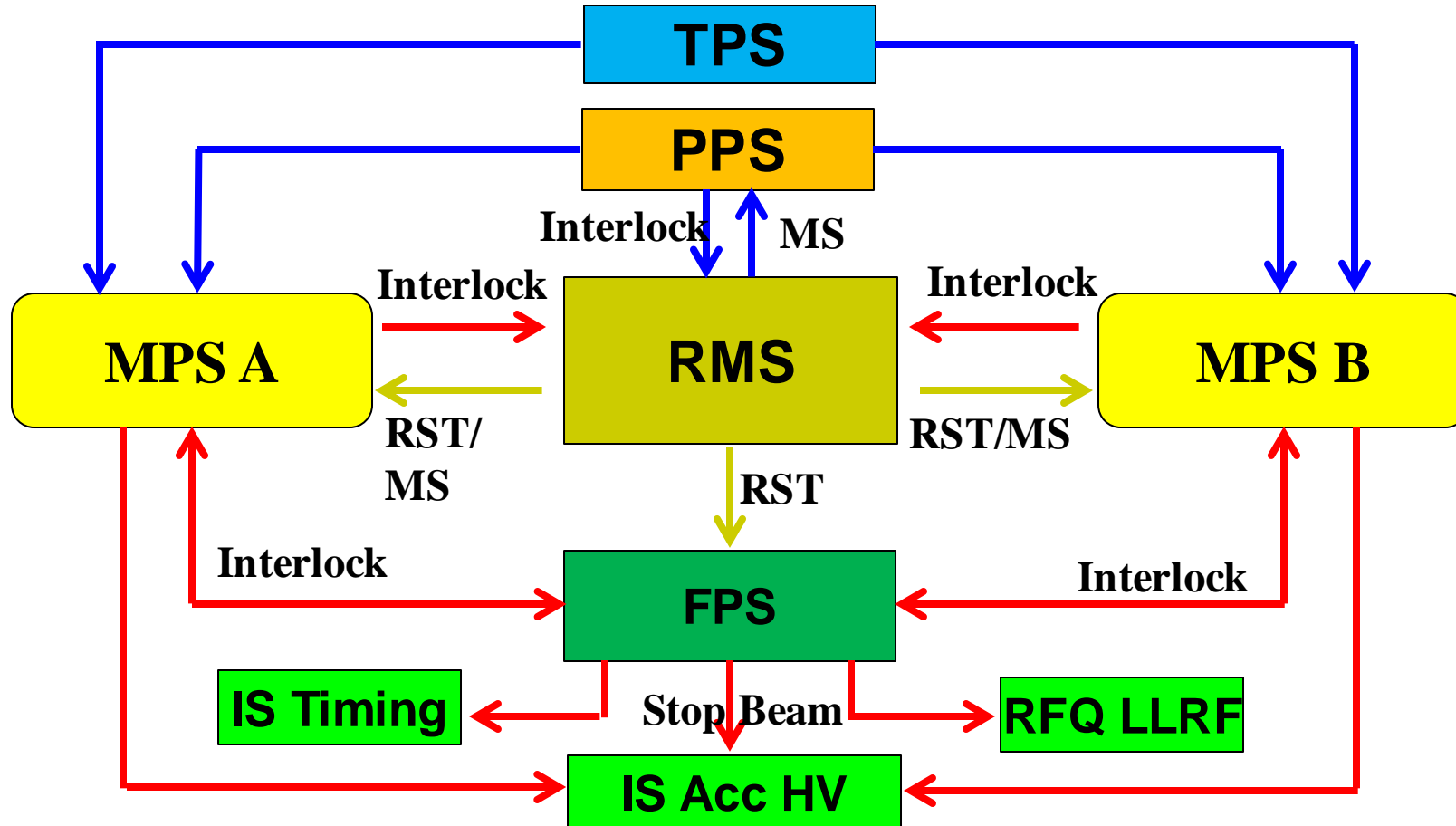

MS: Machine Status

RMS: Run Management System

FPS Architecture and Techniques

- The tree topology was selected by FPS consists of three layers.
- All signals are transmitted through optical fibers.

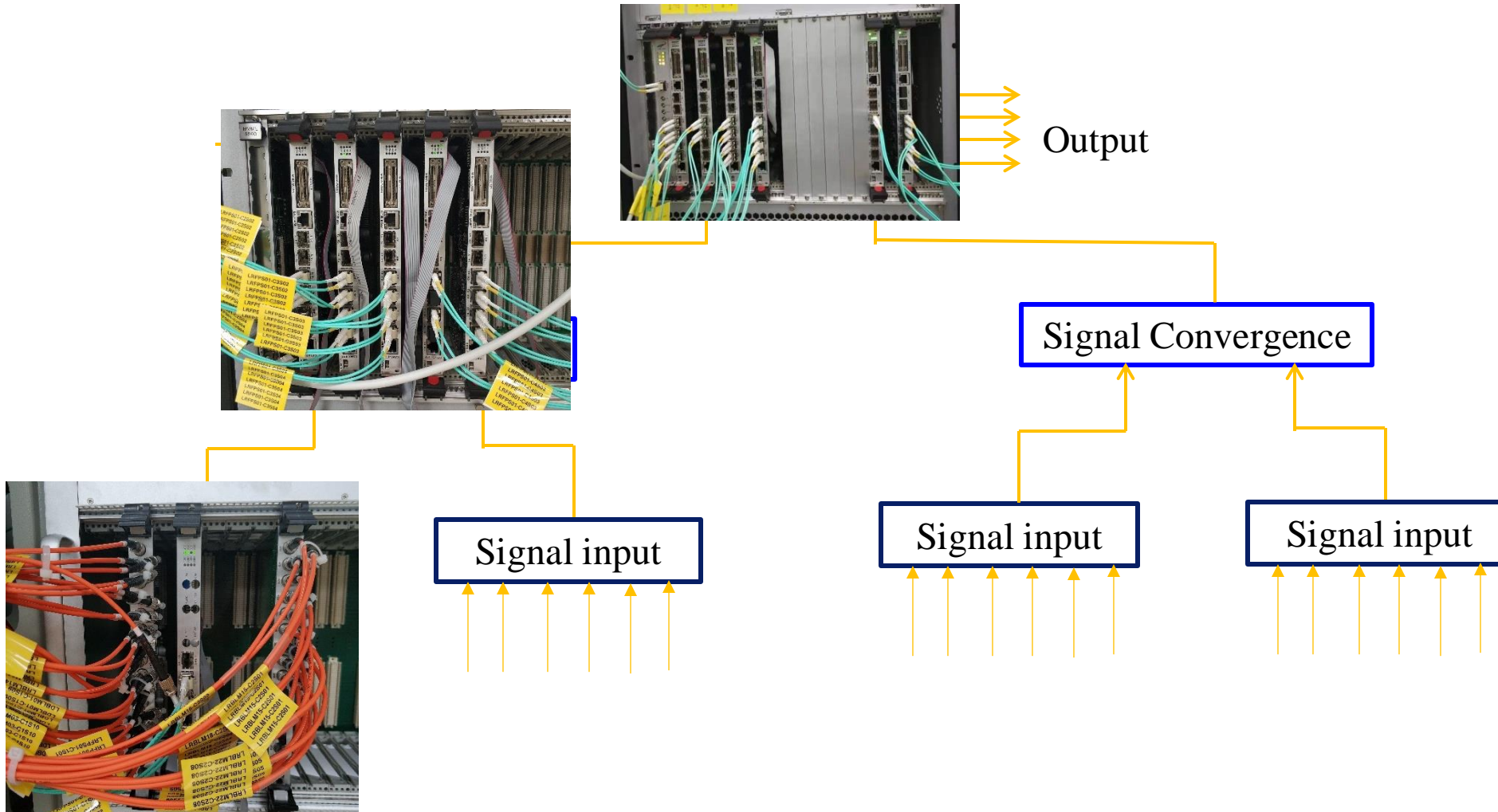



IT Infrastructure

- Increasing network bandwidth and more segmentation for additional requirements.
- Increasing computing, storage and memory resources.

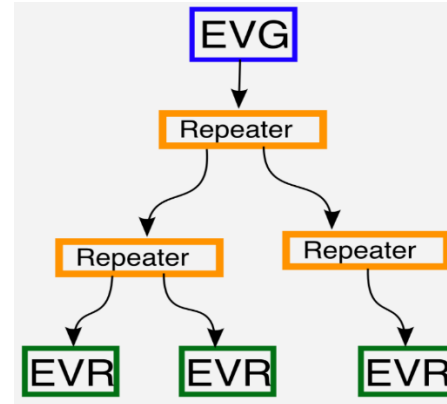

Timing system

- The SoC or μ TCA boards will be deployed for new requirements
- The existing VME form board will be converted to SoC or μ TCA in phase



MPS

- Newly developed SoC boards will be deployed to replace the VME boards used by FPS.
- The existing PLCs used by MPS will be replaced by the domestic PLCs.

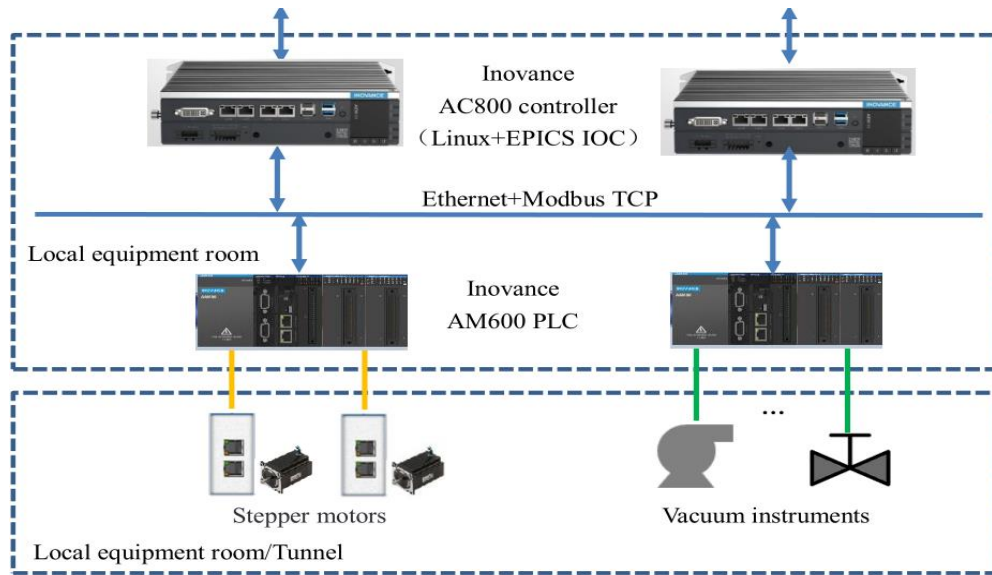

PLC based slow control

- The domestic PLCs will be adopted for the slow control
- EPICS drivers for the domestic PLC has been tested online for more than 3 years

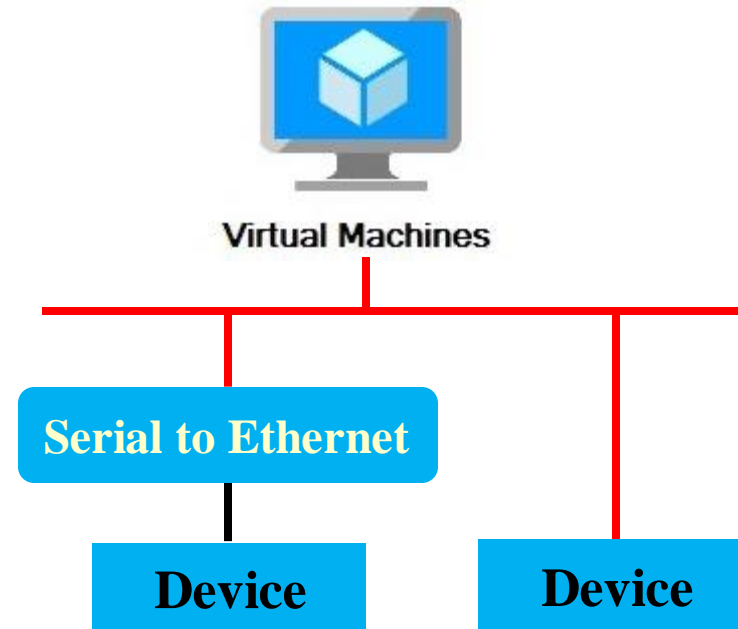

Virtual Machines

- More virtual machines based Soft IOCs will be used to replace the industrial computer based EPICS IOCs
- Easy to manage and maintain, higher availability

Beam Synchronous DAQ system



- BSDAQ system collects data synchronized with beam cycle from the whole accelerator and provide time correlated data
- Can be used for commissioning, troubleshooting, performance monitoring and early fault detection

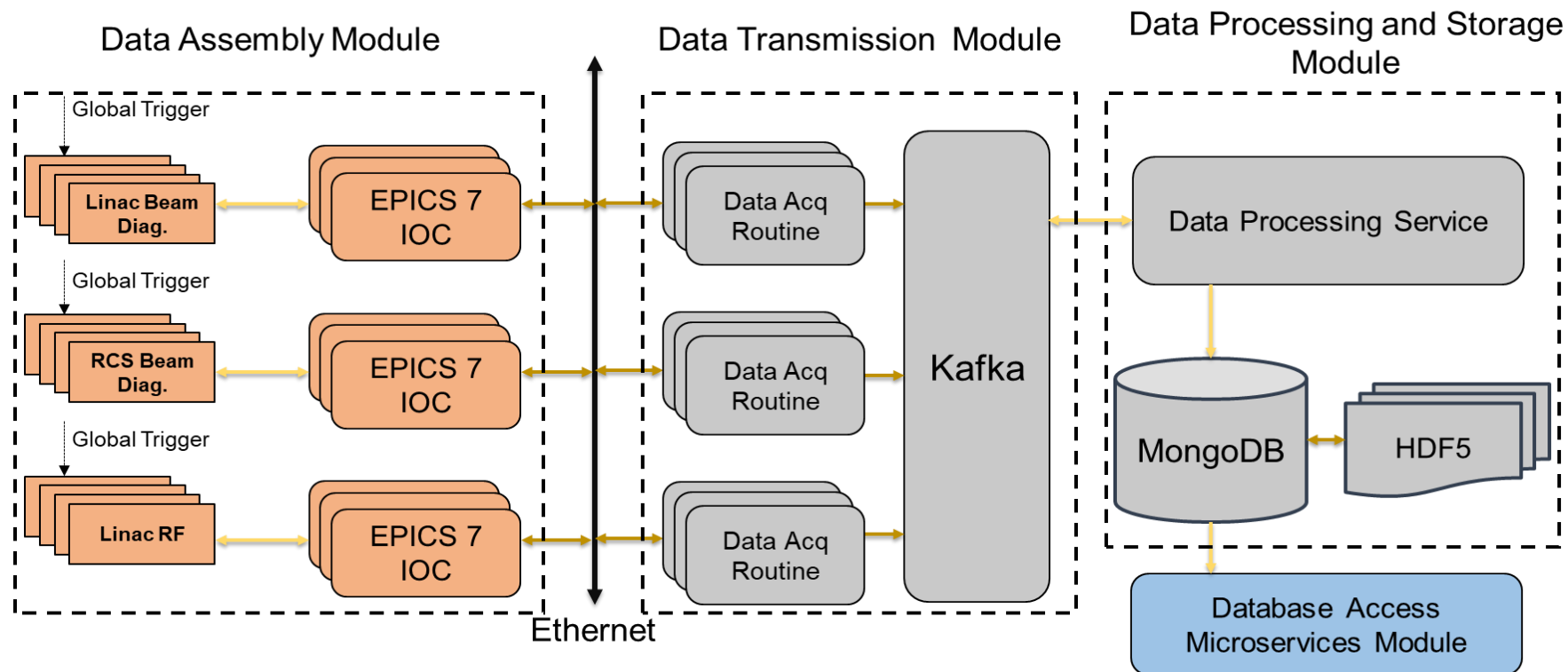

High Level Applications



- **Started to develop from 2018**
- **Manage data and information during accelerator operation and maintenance**
- **Developed based on web and database technologies**
- **This is a continuous effort work based on the requirements**

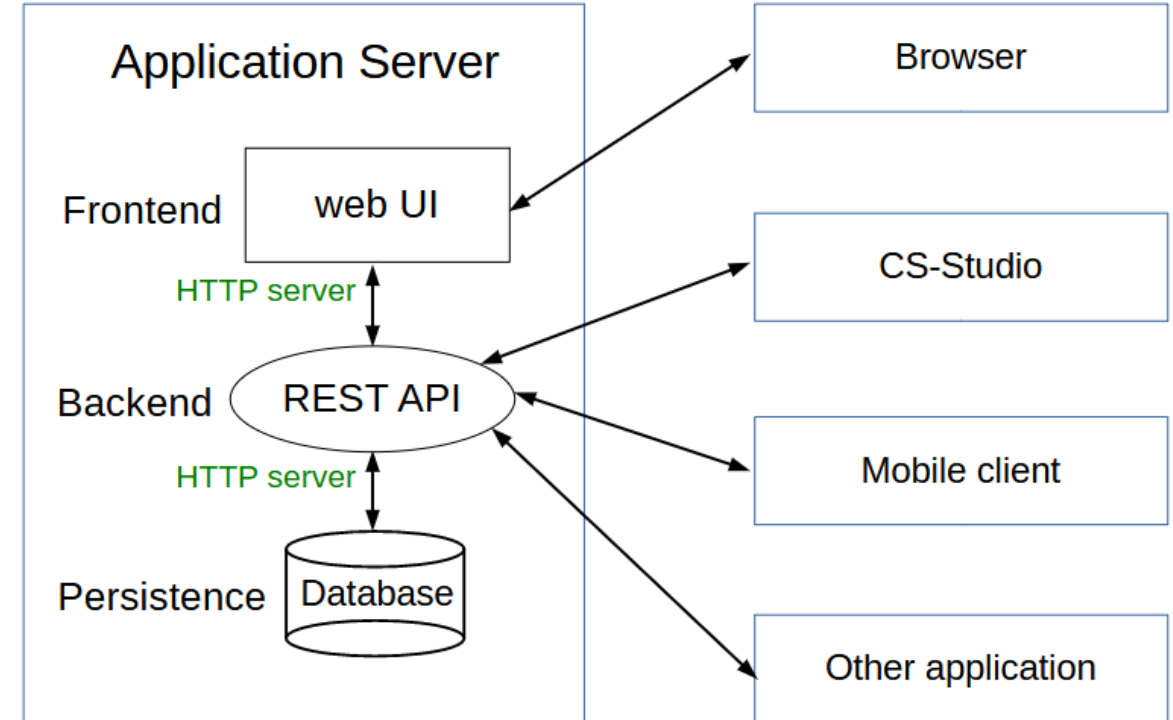

High Level Applications



□ CSNS-II Project Management System

- Manages tasks, parameters, measurement data and budget.
- Included modules
 - Task tracking and management
 - Machine parameter database
 - Magnet measurement database
 - Alignment measurement database
 - Budget tracking system

The screenshot displays the CSNS-II Project Management System interface. The browser address bar shows the URL 10.1.236.82/parameter. The page title is "CSNS-II 加速器工程管理". The interface includes a sidebar with navigation options such as "任务跟踪管理", "参数数据库", "参数查询", "系统组成", "准直数据管理", "磁测数据库", "经费跟踪", "设置", "系统", and "用户". The main content area shows a table of parameters with columns for "区域", "子系统", "设备", "名称", "单位", "数值", "说明", and "操作". The table contains 25 parameters, with the first 6 rows visible in the screenshot.

区域	子系统	设备	名称	单位	数值	说明	操作
ACC	物理		打靶质子束流平均功率	kW	500		✎ ✖ 🔍
ACC	物理		打靶质子束流动能	MeV	1600		✎ ✖ 🔍
ACC	物理		打靶质子束流平均流强	uA	312.5		✎ ✖ 🔍
ACC	物理		重复频率	Hz	25		✎ ✖ 🔍 🟢
ACC	物理		打靶脉冲粒子数	个	7800000000000		✎ ✖ 🔍 🟢
ACC	物理		打靶脉冲电荷量	uC	12.5		✎ ✖ 🔍
ACC	物理		打靶脉冲能量	kJ	20		✎ ✖ 🔍
MEBT	物理		长度	m	2.955		✎ ✖ 🔍
DTL	物理		长度	m	35.448		✎ ✖ 🔍

High Level Applications



□ EPICS PV Browser

- A Web Based EPICS PV Information Query System

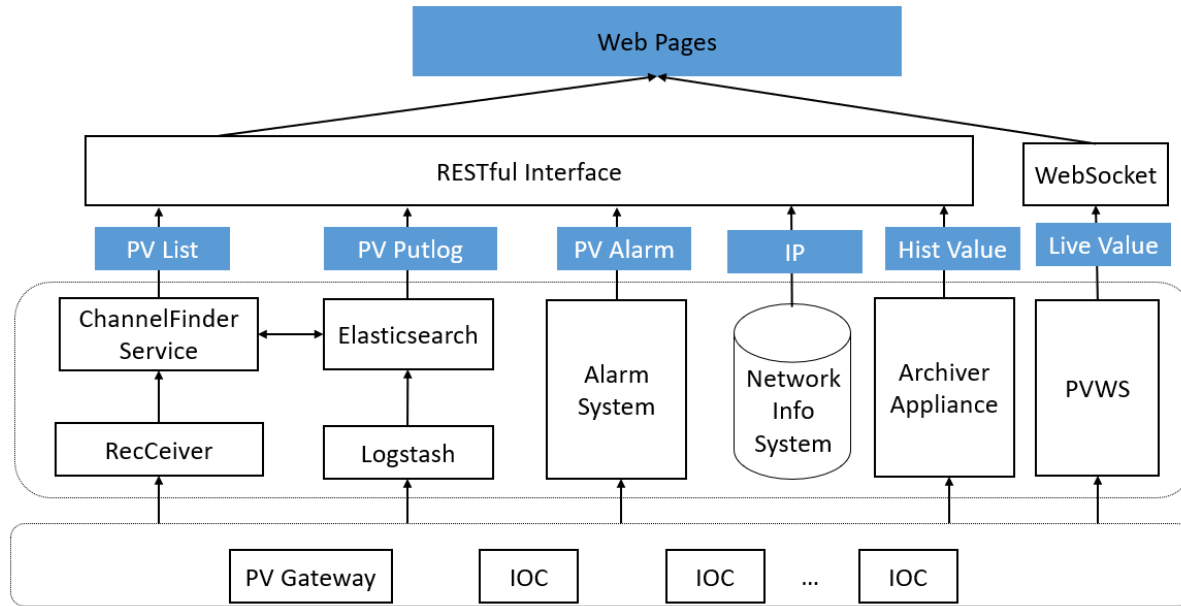

CSNS加速器控制系统运行信息

张玉亮
退出登录

PV信息 IOC状态 PV操作日志 报警信息 网络管理

报警信息 > 当前报警

Active Alarms							
PV	Description	Alarm Severity	Alarm Status	Alarm Time	Alarm Value	PV Serverty	PV Status
Showing 0 to 0 of 0							
Acknowledged Alarms							
PV	Description	Alarm Severity	Alarm Status	Alarm Time	Alarm Value	PV Serverty	PV Status
ACC_RCS_EXT:EXKPPS07:Err	06引出Kicker07电源故障	MAJOR_ACK	STATE_ALARM	2024-10-25 10:00:47	Error	MAJOR	STATE_ALARM
ACC_RCS_PPS:PLC.L11446	隧道允许大风量通风机计时已结束	MINOR_ACK	STATE_ALARM	2024-10-25 09:24:40	ON	MINOR	STATE_ALARM
ACC_RCS_PSC:R4QD11:MagT:Flowbi	18磁铁R4QD11水流量报警	MAJOR_ACK	STATE_ALARM	2024-10-25 17:34:51	Alarm	MAJOR	STATE_ALARM
ACC_DTL2_FPS:intLcln	02DTL2 高频联锁	MAJOR_ACK	STATE_ALARM	2024-10-24 09:09:18	Permanent Alarm	MAJOR	STATE_ALARM
ACC_RCS_MPS:QPS04:Lockbi	18RCS电源QPS04联锁	MAJOR_ACK	STATE_ALARM	2024-10-25 17:34:55	ALARM	MAJOR	STATE_ALARM

□ General purpose applications

- Can be used for CSNS, and can also be used for other facilities

- **Clog (Compact Electronic Logbook System) 2.0**
 - <https://github.com/wanglin86769/clog2>
- **EPICS Channel Access client for Node.js**
 - <https://github.com/wanglin86769/node-epics-ca>
- **EPICS Portable Channel Access Server for Node.js**
 - <https://github.com/wanglin86769/node-epics-pcas>
- **Publishes Archiver Appliance status as EPICS PVs**
 - <https://github.com/wanglin86769/archiver-status>

- **The CSNS accelerator control system was completed in 2018, but the hardware and software platform was determined in 2012. The control system achieved high availability during operation.**
- **The control system has been growing, evolving since original commissioning, some new technologies has been tested and put into operation. It is the time to modernize the control system towards CSNS-II requirements.**
- **Manpower is not enough, we are looking for good engineers and also collaboration.**



Thank you for your attention!