

# RECENT PROGRESS OF WIRE SCANNER SYSTEMS FOR THE KEKB INJECTOR LINAC AND BEAM TRANSPORT LINES

N. Iida, Y. Funakoshi, T. Kawamoto, M. Kikuchi, T. Mimashi, T. Suwada, M. Tanaka, M. Yamauchi, KEK, Japan, S. Yoshida, Kanto Information Service Co., Japan

*Abstract*

Recent progresses of the wire scanner systems of the KEKB injector linac(LINAC) and beam transport lines(BT's) are described. The number of optics matching sections have been expanded from two to seven. The scanning time for each wire has been shortened drastically by doing a measurement without stopping the wire. A unified user-friendly software for wire scanner measurements has been made. Daily measurements by using this new panel are actually useful to watch machine conditions of LINAC and BT. The wire scanners have also been used for a measurement of a beam energy distribution.

## 1 INTRODUCTION

The KEKB accelerator is a high luminosity  $e^+e^-$  collider. In order to maintain high luminosity, a well-controlled operation is required for minimizing tuning time and also for a stable operation. The distances from an electron gun to the entrances of the KEKB rings are about 1km. A wire scanner(WS) for monitoring beam profiles non-destructively is useful to carry beams through such long beam lines. A design of WS's and beam tests of a prototype were reported elsewhere[1, 2, 3]. Tangsten wires of  $100\mu\text{m}$  in diameter are used. At least three WS's are needed to determine beam emittance and Twiss parameters in the optics matching. For redundancy, four wire scanners are mounted at each matching section. The first trial for optics matching by using the wire scanners in the positron BT line was successfully done[4]. We established seven such matching sections in LINAC and BT's. In addition, WS's installed at large dispersion are used to measure an energy distribution.

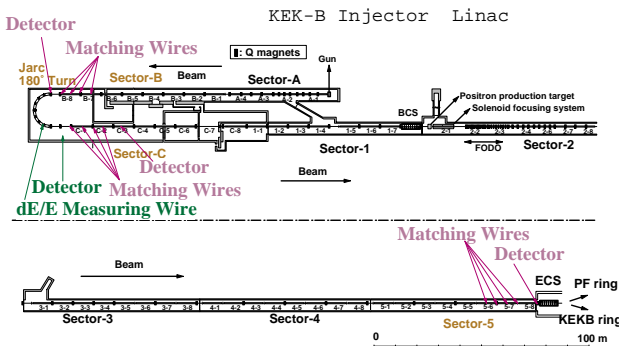

Figure 1: KEKB injector LINAC

## 2 ARRANGEMENT OF WIRE SCANNER

### 2.1 Overview of LINAC and BT

An electron beam is transported to the ring as follows. At the head of LINAC(see Fig. 1), an electron gun generates about 1nC electrons per bunch, which are accelerated up to 1.7GeV in sector-A and sector-B and led to J arc. The electrons turned by six bending magnets in J arc are accelerated up to 8GeV when passing from sector-C to sector-5, and enter into the BT line. The length of LINAC is about 600m. In BT including four arcs, the electrons are transported about 500m long to be injected into the KEKB electron ring(HER). On the other hand, for positrons, 10nC electrons per bunch generated at the same electron gun hit on a target to obtain about 1.1nC positrons. The positrons are accelerated up to 3.5GeV. At the end of LINAC, they pass through Energy Compaction System(ECS). The electrons and positrons go different ways after the first bending magnet of ECS. In the first 350m of BT, the two beams go through a common tunnel, where beam lines have a double-decked structure. After that, the beams are carried in separate beam lines to different injection points.

### 2.2 Arrangement of wire scanners

Fig. 1 and 2 show where the wire scanners are arranged. In the matching systems, four wire scanners make one set. In LINAC, the sectors of B, C and 5 have each set. The same wire scanners and quadrupole magnets are used for both of electron and positron optics measurements.

At the sector-B, the wire system is used to fit the optics to that of J arc. The matching system at the sector-C is used for the optics diagnostics and correction after J arc. Optics matching for the electron and positron beams is also done at the end of LINAC(sector-5). Since acceptance of the junc-

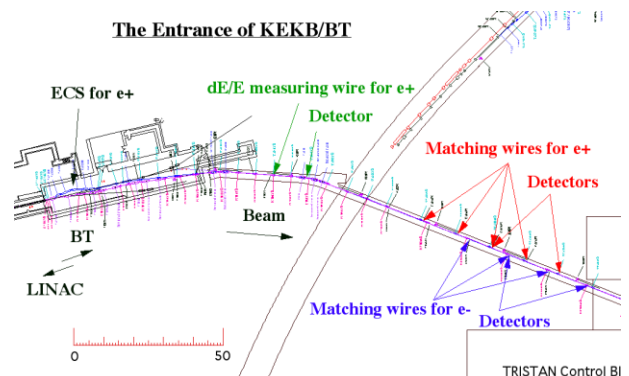

Figure 2: The entrance part of KEKB/BT

tion from LINAC to BT( including ECS for the positron ) is narrow, optics matching is important for efficient beam transmission. We have additional matching sections at the entrance of the electron and positron BT lines. One more WS is equipped at each end of BT's. We do not use those WS's at present yet.

When we choose locations of the four wire scanners, we have to pay attention to betatron phase advance among them. Too small phase advance brings bad accuracy in the optics measurement. In BT's, the phase advance is suitable for the measurement since the wires are installed in  $2\pi$  sections. However in LINAC, originally, four wires had been bunched in a small phase advanced section. We moved one wire beyond a quadrupole to keep enough phase advance.

There are two measurement points for energy spread. One is at J arc of LINAC where the dispersion is 1m. Another measurement point is at the entrance of positron BT, where the dispersion is 3m. At both points, the beam sizes from energy spreads are large enough compared with that from betatron.

Bremsstrahlung lights are emitted from a wire hit by a beam and produce showers everywhere at walls of beam pipes. The photomultiplier tube(PMT) at 5~10 m downstream of the wires detects the showers. The PMT's used in BT's(H7195(R329-02)/Hamamatsu) are surrounded by leads 100mm thick, which shield backgrounds produced by a beam halo. We adopted small PMT's for LINAC(E5996(R5990-U)/Hamamatsu) with which we can decrease the amount of shield leads. This is because the leads are mounted on the same supports for other structures and 30kg is the limit for additional components.

### 3 OPERATION

#### 3.1 Matching system

In this section, panels of wire scanner systems which are used for daily operations are described.

First a selection panel is opened to choose a region to be measured as shown in Fig. 3. In the next panel(Fig. 4), beam sizes at four wires in this region are measured. The widths(devided by  $\sqrt{2}$ ) of left most and right most peaks of the three in the graph show the vertical and horizontal beam sizes, respectively. The data taking is done without stopping the wire. With this new data taking method a measuring time has been remarkably reduced. It takes 30sec for a wire to move a 120mm stroke with a 25Hz beam repetition. We can finish all measurements of Fig. 4 within

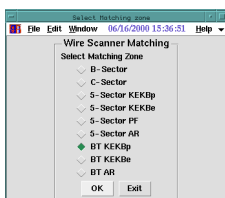

Figure 3: A region for optics matching is selected

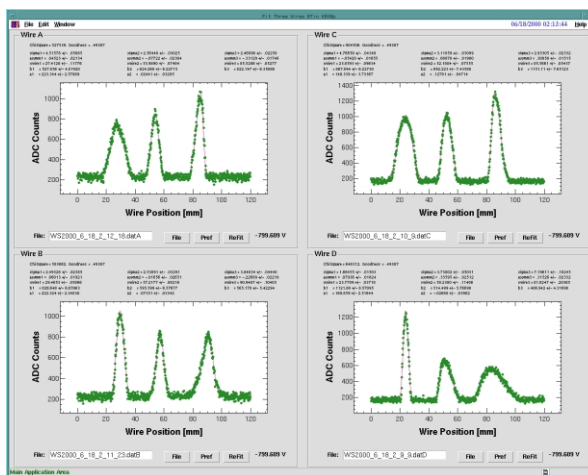

Figure 4: Typical beam profiles in positron BT line.

five minutes. The vibration of a moving wire was measured with a prototype[3]. The result was  $\pm 10\mu\text{m}$  in peak-to-peak which was small enough compared with the beam size(0.5~5mm) at LINAC and BT.

The optics calculations are done in the third panel(Fig. 5). In LINAC, beams are accelerated among wires. The emittance shrinks in the ratio of beam energy,  $\gamma$ (Lorentz factor). In the calculation, this effect is taken into account by using the cavity voltages including the beam loading.

The left part of Fig. 5 shows optics parameters as ellipses in the phase space calculated from measured beam sizes. The ellipses are drawn so that the distance from the ellipse to the four pairs of lines obtained from the measured beam sizes is minimum. The upper graph shows the horizontal phase space and the lower shows the vertical one. The center part of this figure shows three ellipses. Two of these denote the measurement and the design. The third ellipse is similar to that of the measurement with emittance multiplied by a measured BMAG[5]. They give a visual appeal of the difference between measured and design optics.

The right part shows calculated optics parameters( $\alpha, \beta, \epsilon$

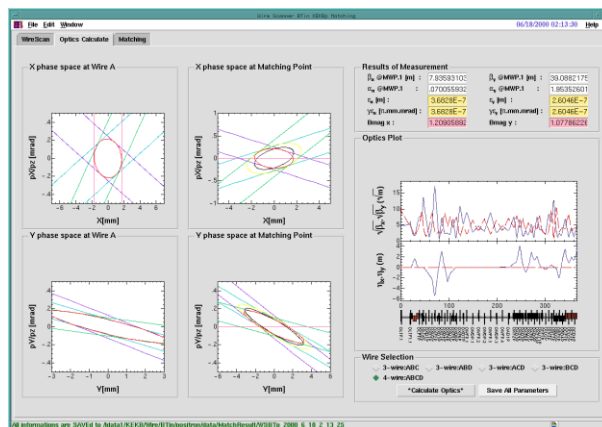

Figure 5: Optics calculation from measurements.

and BMAG). The  $\beta$  functions from the measurement along the beam line are also shown. If the obtained BMAG values are rather bigger than unity, an optics matching is done using quadrupole magnets equipped on the upstream of the wire scanners. Fig. 6 shows a matched optics to the design. The bar graph of this figure shows strength of the magnets before matching (green, left side) and after matching (red, right side). When each strength of after matching is within the limit of power supplies, the new values of quadrupoles can be set.

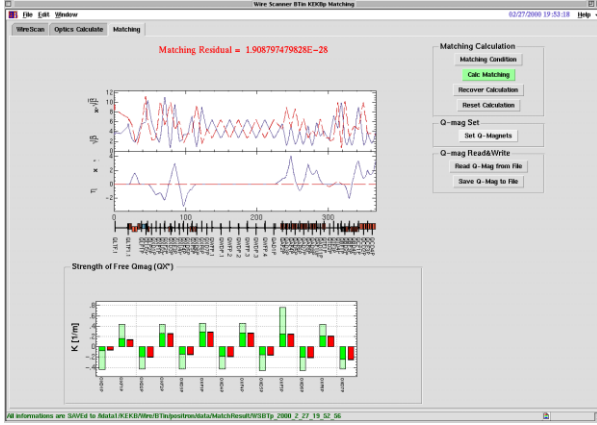

Figure 6: Optics matching panel.

### 3.2 Energy spread measurement

Fig. 7 shows a panel for energy spread measurement of a 10nC electron beam in J arc. The upper graph shows the horizontal distribution at the wire scanner. The background level is calculated by fitting with an asymmetric gaussian and a linear. The full width including 90% of the area at this distribution after the background subtraction is defined as a full beam size. The energy spread is calculated by;  $dE/E = \sqrt{\sigma^2 - \varepsilon\beta/\eta}$ , where  $\sigma$  is a measured beam size,  $\varepsilon$  and  $\beta$  are emittance and  $\beta$  function extrapolated from the nearest matching section and  $\eta$  is a designed dispersion. The lower part of this panel shows trend plots of various parameters calculated from the measured distribution, area, position, full width, energy spread, skewness and kurtosis.

We measure the optics parameters and the energy distributions at every wire scanner section everyday as possible. All measured data are logged and the history of each parameter can be seen with a log viewer as shown in Fig. 8.

## 4 CONCLUSION AND FUTURE PLAN

The optics parameters( $\alpha$ ,  $\beta$ ,  $\varepsilon$  and BMAG) and energy spreads are measured everyday with the wire scanner systems. The new data taking system without stopping wires is successful in reducing time to get a beam size. The daily measurements by using wire scanners are very useful to watch machine conditions of LINAC and BT.

In future, we will try optics matching from BT to the KEKB rings. A wire scanner has been already installed

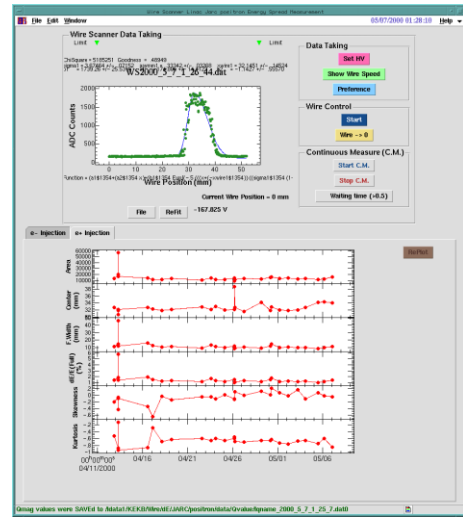

Figure 7: Energy spread for primary electrons in J arc

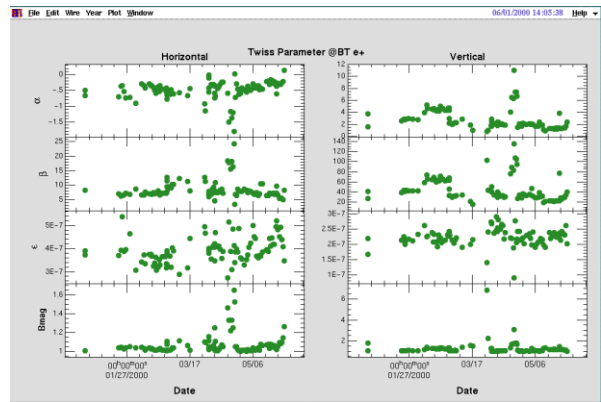

Figure 8: Trend of optics parameters in positron BT line.

at each end of electron and positron BT. The waist scan is needed with varying quadrupole magnets upstream of the wire scanner. That completes an entire matching system of LINAC to rings.

## REFERENCES

- [1] T. Suwada et al., "First Beam Test Result of a Prototype Wire Scanner for the KEKB Injector LINAC and BT Lines", Proceedings of the 11th Sympo. on Accelerator Science and Technology, 1997, Hyogo, Japan,
- [2] Y. Funakoshi et al., "Beam Tests of a Wire Scanner for The KEKB Injector LINAC AND Beam Transport Line", Proceedings of the APAC98
- [3] N. Iida et al., "A Method for Measuring Vibrations in Wire Scanner Beam Profile Monitors", Proceedings of the APAC98
- [4] N. Iida et al., "The First Results of Optics Matching Using Wire Scanners for the KEKB Beam Transport Line", Proceedings of the PAC99
- [5] J. T. Seeman et al., SLAC-PUB-5705 Aug. 1992