

# UPGRADE OF BPM DAQ SYSTEM FOR SUPERKEKB INJECTOR LINAC

M. Satoh<sup>#</sup>, F. Miyahara, T. Suwada, and K. Furukawa, Accelerator Laboratory, High Energy Accelerator Research Organization (KEK), 1-1 Oho, Tsukuba, Ibaraki 305-0801, Japan

T. Kudou and S. Kusano, Mitsubishi Electric System & Service Co., Ltd, 2-8-8 Umezono, Tsukuba, Ibaraki 305-0045, Japan

## Abstract

The KEK electron/positron linac is a 600-m-long injector that provides the beams with different energy to four independent storage rings. The non-destructive beam position monitor (BPM) is an indispensable diagnostic tool for a long-term stable beam operation. In the KEK linac, about one hundred BPMs with the four strip-line type electrodes are utilized for the beam orbit and charge measurement. The measured beam orbit data is utilized for the beam orbit and energy feedback loops. The present data acquisition (DAQ) system for BPM comprises the twenty four fast digital oscilloscopes. They can work as a WindowsXP-based EPICS IOC.

Toward the SuperKEKB project, the upgrade of injector linac is going on for increasing the beam intensity and reducing the emittance. The electron beam emittance will be reduced one-fifth smaller than that of former KEKB project by using a new rf gun. The measurement precision of beam position is strongly required for the low emittance beam transport. Two new DAQ systems are under development as a candidate aiming at the measurement precision of 10  $\mu\text{m}$ . In this paper, the system description and the result of performance evaluation are presented in detail.

## INTRODUCTION

The KEK linac sequentially provides the electron and positron beams with different energies and intensities for four independent storage rings as shown in Table 1. For the improvement of integrated luminosity and stored current stability, the simultaneous injection between KEKB electron and positron rings has been strongly required. In addition, the PF top-up injection has been also strongly demanded even during the KEKB injection. For these reasons, the injector upgrade project started in 2004 so that the simultaneous top-up of KEKB electron/positron and PF rings. This upgrade was completed in April 2009, and the simultaneous top-up injection among three independent rings was successfully achieved [1].

Whereas the KEKB project has completed in the summer of 2010, the Super KEKB project has started for aiming at the peak luminosity of 40 times higher than that of former KEKB project. For this purpose, the injector linac upgrade is ongoing for increasing the beam intensity and reducing the emittance. In this linac upgrade, main

issues are the construction of positron damping ring, the development of a new positron capture system for increasing the positron charge of four times present, and the installation of a low emittance electron gun as shown in Fig. 1. The performance required of beam position measurement is a higher precision of ten micro meters for the stable low emittance beam transport.

Table 1: Injection beam energy and charge for each ring.

	KEKB e- /SuperKEKB e-	KEKB e+/SuperKEKB e+	PF	PF- AR
Injection beam energy (GeV)	8/7	3.5/4	2.5	3
Beam charge /bunch (nC)	1/5	1 (10 <sup>*</sup> )/4(10 <sup>*</sup> )	0.3	0.3

\*Primary electron for positron production

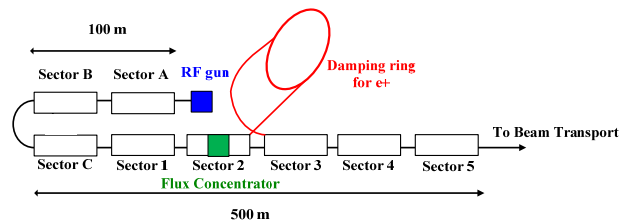

Figure 1: Schematics drawing of SuperKEKB injector linac. The coloured parts will be newly installed for SuperKEKB project.

## LOW EMITTANCE PRESERVATION

For the SuperKEKB project, the emittance of positron beam will be reduced 10 mm-mrad from 2100 mm-mrad by using the damping ring newly constructed. The emittance of electron beam will be reduced 20 mm-mrad from 100 by using a low emittance rf gun under development. The low emittance electron beam should be delivered to the ring without a damping ring due to cost reduction.

In the high intensity linacs, the accelerating structures should be precisely aligned since its misalignment causes the large emittance growth due to the short range transverse wake field. The simulation result based on the SuperKEKB linac parameters shows that the acceptable misalignment of accelerating structure is less than the standard deviation of 0.1 mm. However, it seems to be difficult to achieve such fine component alignment in a practical manner. In our plan, we will apply BNS damping scheme at Sector A and Sector B, and the bunch

<sup>#</sup> masanori.satoh@kek.jp

compression at the arc section to mitigate the emittance growth. In addition, at the beginning of Sector C, the fine beam position and angle controls will be carried out for the emittance preservation at the end of Sector 5. In prior to these tactics, the ordinary beam base alignment will also be conducted. For these reasons, the beam position should be precisely measured and controlled.

## SYSTEM DESCRIPTION

### Present System

In the KEK linac, many kinds of feedback loops have been developed and utilized to stabilize the beam orbit, energy, and energy spread [2]. These feedback loops make use of the beam position information acquired by the non-destructive BPMs [3]. About one hundred stripline-type BPMs have been installed in the KEK linac. The twenty four front-end systems have been installed in the linac klystron gallery at a nearly equal interval along the beam line. The each DAQ system deals with the analog signals of 3 to 6 BPMs. A schematic drawing the present DAQ system is shown in Fig. 2. It comprises a fast digital oscilloscope (Tektronix DPO7104; 10 GSa/s, 4 channels, 8 bit, CPU P4/3.4 GHz, Gigabit-Ethernet) and a cable combiner box.

The four signals coming from one BPM are fed to two signal combiners (vertical and horizontal) together with the signals from other BPMs. The delay cables corresponding to the time delay of about 7 ns are installed to avoid the waveform overlapping inside the signal combiners. The each output of combiner box is equally divided again into two signals. Since it is impossible to change the vertical scale of oscilloscope in every 50 Hz, CH1/CH2 and CH3/CH4 are used for the low charge and the high charge modes, respectively. The waveforms digitized at a sampling rate of 10 GSa/s are processed and calculated into the beam parameters (beam charge, horizontal and vertical positions), taking into account the calibration coefficients measured in advance. The DAQ

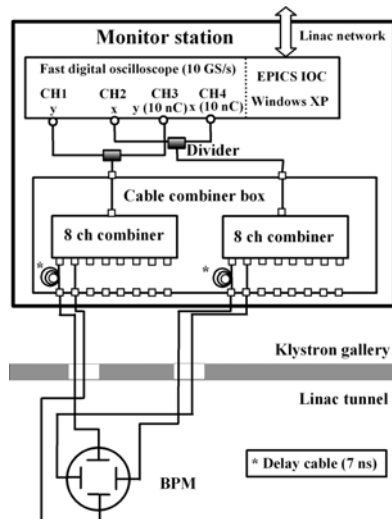

Figure 2: Schematic drawing of the present BPM DAQ system.

software has been developed by using Microsoft Visual Studio 2005 C++, TekVisa, and EPICS base R3.14.8.2. The DAQ software is running on the fast oscilloscope, and each oscilloscope works as an EPICS IOC [4]. The similar DAQ system is also utilized for the KEKB and PF-AR beam transport lines [5].

### New System

The measurement precision of 10  $\mu\text{m}$  or better is one of key requirements for the new DAQ system. In addition, all beam positions up to 50 Hz should be measured. Since the SuperKEKB injector linac will be operated base on a simultaneous top-up of the four independent rings, the electron/positron beams with different energies and amounts of charges are delivered in every 20 ms. For this reason, the fast and precise attenuation control is also key requirement for the new system.

Currently, we have two candidates as a new system. One of them is a VME-based module which has been reported in elsewhere [6]. Another is Libera Single Pass Electron (LSPE) unit from Instrumentation Technologies tested in this study [7]. It is a module dedicated for BPM DAQ and widely used at many recent accelerator facilities. LSPE unit comprises a 16-bit ADC with the sampling frequency of 160 MHz, two surface acoustic wave (SAW) filters with the center frequency of 522 MHz and the bandwidth of 24 MHz in each channel. It has also the variable attenuator with maximum attenuation of 31 dB. The attenuation level can be adjusted in 1 dB step. A single-board computer (SBC) and a field-programmable gate array (FPGA) are utilized for processing the digitized waveform.

The typical analog signal shape from the BPM electrode is a bipolar with the duration of 3 ns. Applying double SAW filters inside LSPE, the signal is stretched to around 100 ns as shown in Fig. 3. Using about 15 sampled data points, the square root of square summation of them is used as signal amplitude corresponding to the each electrode. The data processing of digitized waveform is carried out on the FPGA. The calculated beam position and other data are transferred to SBC which is based on the embedded Linux operating system with fast Gigabit Ethernet. The client software like beam orbit display can retrieve the information of beam position and bunch

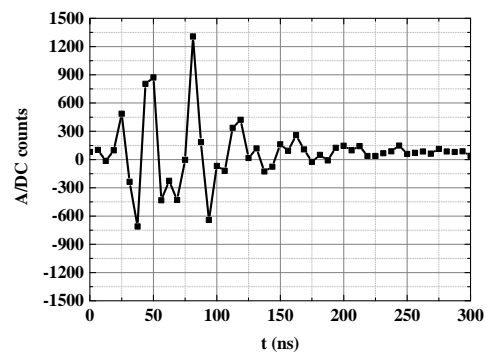

Figure 3: Raw signal waveform measured by LSPE.

charge through the EPICS CA protocol.

## RESULTS OF 3-BPM MEASUREMENT

### Present System

The beam position measurement precision of the present system was evaluated by the 3-BPM method [3]. We conducted the beam test by using the electron beam with the charge of 0.3 nC at Sector 3 in Fig. 1. Applying the 5 different settings to a steering magnet situated upstream of the used BPMs, the beam positions were synchronously measured with three BPMs. For each steering settings, around 400 data were measured and analyzed. Figure 4 shows the residual distribution between the measured and estimated horizontal beam positions at the third BPM. Here, the estimated beam positions at the third BPM can be calculated with the linear multiple regression analysis by using the measured position data at first and second BPMs. The results of the horizontal and vertical directions are 26.3  $\mu\text{m}$  and 25.1  $\mu\text{m}$ , respectively. In the present system, the position measurement precision is limited by the ADC resolution of 8 bit.

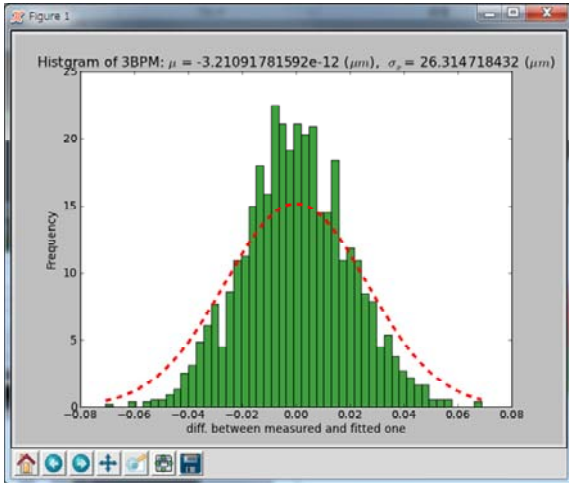

Figure 4: Residual distribution between the measured and estimated horizontal beam positions at the third BPM by the present system.

### New System

In prior to the 3-BPM experiment by using LSPE, we should precisely adjust the four signals from different electrodes since a small fraction of signal leaks beyond the predetermined sampling window of 96 ns duration. In LSPE, the channel A and channel C are used for calculating the horizontal beam position. In order to estimate the sensitivity of the signal phase misalignment to the measurement precision, we evaluated the measurement precision by changing the delay setting of channel A. Here, the input signals are generated by a pulse signal generator instead of the real electron beam. The optimum adjustment of delay setting shows the high

measurement precision of 1.6  $\mu\text{m}$  though the precision deteriorates larger than 10  $\mu\text{m}$  with the large phase misalignment. In Fig. 5, the maximum setting of 4000 corresponds to the timing delay of around 1.5 ns.

After the optimization of phase alignment, we carried out the 3-BPM experiment with the same BPMs and steering magnets used for the present system evaluation. The result is shown in Fig. 6. The measurement precisions of horizontal and vertical directions are 7.05  $\mu\text{m}$  and 7.06  $\mu\text{m}$ , respectively. We confirmed that the LSPE unit can satisfy our target performance of 10  $\mu\text{m}$ .

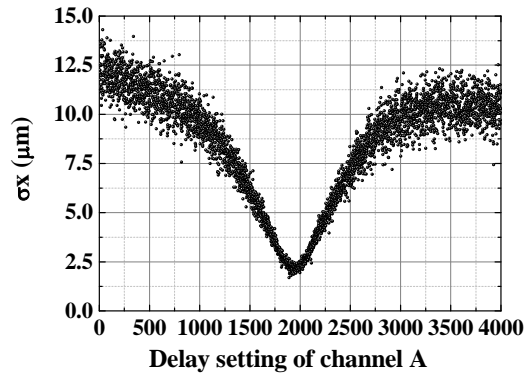

Figure 5: Measurement precision for changing the delay settings of channel A.

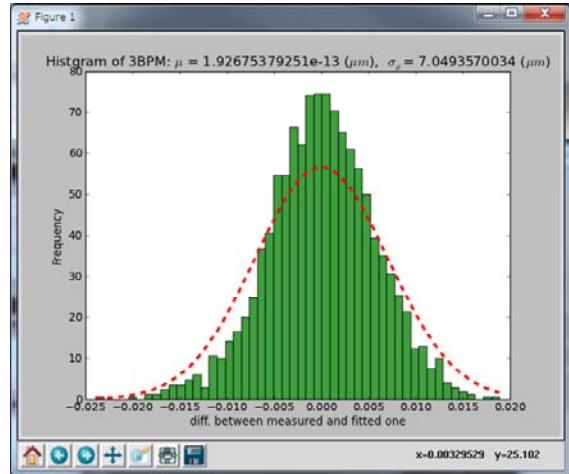

Figure 6: Residual distribution between the measured and estimated horizontal beam positions at the third BPM by the LSPE unit.

## LONG-TERM STABILITY

In the KEK linac BPM system, a strip-line electrode of BPM is connected by 35-m-long coaxial cable with BPM DAQ system installed at klystron gallery. For the long-term operation, the measured beam position could be varied even for the constant real beam position since the temperature variation may affect the ADC gain and the electrical conductivity of long coaxial cable. For this reason, the system stability during a long-term period was

also evaluated. In this measurement, the signal generated by a pulse signal generator was equally divided into four signals, and each of them was connected to the SAM connector at the linac tunnel. The other side of cable was fed to each channel of LSPE situated at linac klystron gallery through the 35-m-long coaxial cable. Figure 7 shows the measured position variations in two days measurement period. In this experiment, the temperature variations at the linac tunnel and the klystron gallery were 1.5°C and 4.5°C, respectively because the air conditioner operated only from 8 a.m. to 8 p.m. due to the summer maintenance period. From Fig. 7, the maximum position drift is around  $\pm 2 \mu\text{m}$ . Its stability is enough for our purpose because the temperature can be controlled within 1°C during the real beam operation.

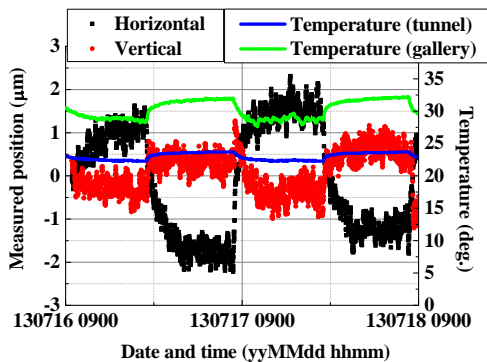

Figure 7: Long-term measurement accuracy during two days by a pulse signal generator.

## SECOND BUNCH MEASUREMENT ACCURACY

The measurement accuracy of second bunch beam position is also an important figure of merit. We measured the impact of first bunch signal variation on the second bunch measurement. By using the experimental setup as shown in Fig. 8, the simulated second bunch position was measured when the simulated first bunch signal intensity was intensively changed. As consequence of the simulated first bunch intentional damping, the simulated second bunch measurement accuracy is estimated within  $10 \mu\text{m}$  as shown in Fig. 9. Another experimental result shows the first bunch position variation from -2.25 mm to 2.25 mm affect the measured beam position of second bunch with 3.44% as reported in elsewhere [8]. Its result means that the  $100 \mu\text{m}$  position offset of first bunch causes the second bunch measurement error of  $3.44 \mu\text{m}$ . These results are acceptable performance for the real beam operation.

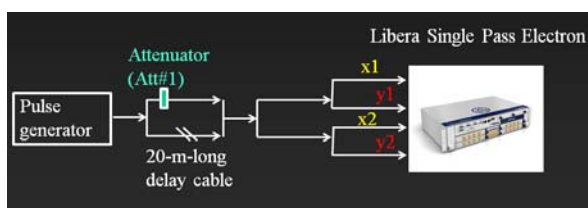

Fig. 8: Experimental setup for evaluating the simulated second bunch position accuracy.

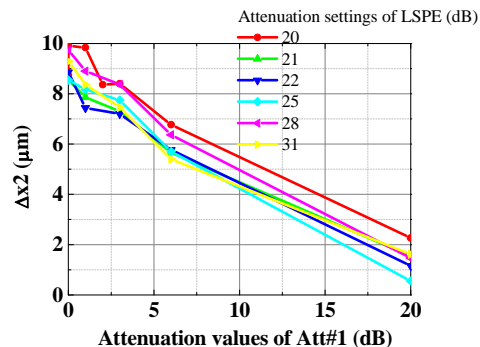

Figure 9: Variation of second bunch measurement accuracy by changing the attenuator setting of first bunch simulated signal.

## SUMMARY AND FUTURE PLAN

Toward the SuperKEKB project, the high precision beam position measurement and control are strongly required for the low emittance electron beam transport without a damping ring. For this reason, the present BPM DAQ system should be replaced by the new one with the higher measurement precision. We conducted the performance evaluation of LSPE unit as a new system candidate. The result of 3-BPM measurement confirms that the both of horizontal and vertical measurement precisions are around  $7 \mu\text{m}$ . These results are surpassing the design goal of  $10 \mu\text{m}$ . After comparing the performances between LSPE and another candidate of VME-based one under development, one of them will be started in mass production and installed in the next fiscal year.

## ACKNOWLEDGMENTS

The authors would like to thank Mr. Matjaz Znidarcic from Instrumentation Technologies for helping 3-BPM experiment.

## REFERENCES

- [1] M. Satoh et al., in Proceedings of Linear Accelerator Conference LINAC2010, Tsukuba, Japan, pp.703-707 (2010).
- [2] T. Suwada et al., Phys. Rev. ST Accel. Beams 8, 112802 (2005).
- [3] T. Suwada et al., Nuclear Instruments and Methods in Physics Research A 440, pp.307-319 (2000).
- [4] M. Satoh et al., in Proceedings of ICALEPCS2009, Kobe, Japan, pp.567-569 (2009).
- [5] T. Aoyama et al., in Proceedings of ICALEPCS2009, Kobe, Japan, pp.495-497 (2009).
- [6] R. Ichimiya et al., in Proceedings of IBIC2013, Oxford, UK, Sep. 16-19, 2013.
- [7] <http://www.i-tech.si/>.
- [8] M. Znidarcic et al., in Proceedings of FEL2013, Manhattan, USA, Aug. 26-30, 2013.