

## STATUS OF COMPACT SR RING "AURORA-2S"

Hiroki MIYADE, Hirohiko MURATA, Daizo AMANO, Toshitada HORI, Takeshi TAKAYAMA  
 Research & Development Center, Sumitomo Heavy Industries, Ltd.  
 2-1-1 Yato-cho, Tanashi-city, Tokyo 188-8585 Japan

### Abstract

From January 1998 we started the beam test of "AURORA-2S"(A2S) and have obtained some fruitful results, which are more than 1000mA injection current, more than 500mA stored current, 640mA/min injection speed, and so on. In the present days A2S is operated continuously and supplies the light to the users who investigate the X-ray lithography. In August 1999 the integrated current exceeded 300A.H and the lifetime reached 240min at 500mA. Now we are planning to inhibit the coupled bunch instability with a Landau cavity and to lengthen the Touschek lifetime with a skew sextupole magnet. With these reconstruction it is expected that we can obtain more excellent performance.

### 1 Introduction

Sumitomo Heavy Industries, Ltd. has been developing compact SR rings since 1986. The target is for industrial use, especially for X-ray lithography. The first "AURORA", which is constructed with a superconducting magnet, has the ultimate shape of compactness. Moreover the iron yoke of the single circular magnet surrounds the whole machine, therefore it has a function of self-shielding.

After construction and operation in our laboratory, the machine was transferred to Ritsumeikan University in 1995. It has been supplying the light to various users not only for X-ray lithography but also for other investigations since then [1].

"AURORA-2" (A2) is a new type compact SR source. The outstanding feature lies in normal conducting bending magnets excited up to 2.7 Tesla. Operation and maintenance of the ring are simplified in the results compared with the superconducting's [2].

There are two types of A2. One is "AURORA-2D" (A2D) for the scientific research. A2D has two long straight sections where insertion devices can be installed. A2D is at Hiroshima University, named HiSOR, with two undulators and has been routinely operated since 1997 [3].

For "AURORA-2S" (A2S), which is optimized for the industrial use, the straight sections are shortened and the whole size becomes as small as possible. A2S is designed as the size of the electron beam keeps uniformity in the bending magnet, therefore it can provide same light through each port. Furthermore lead and polyethylene surround the whole machine for radiation shielding so that the wall of the machine room can be thinned.

Parameters of A2S are summarized in Table 1. Fig. 1 and Fig. 2 show the overall view and the schematic view respectively.

Table 1  
 PARAMETERS OF AURORA-2S

Energy: Storage	0.7	GeV
Injection	0.15	GeV
Circumference	10.97	m
Harmonic number	7	
RF frequency	191.2	MHz
Energy Loss	24.42	keV/turn
Tune: horizontal	1.46	
vertical	0.73	
Natural emittance	527.6	$\pi$ nm.rad
Radiation damping:		
horizontal	2.13	msec
vertical	2.10	msec
longitudinal	1.04	msec

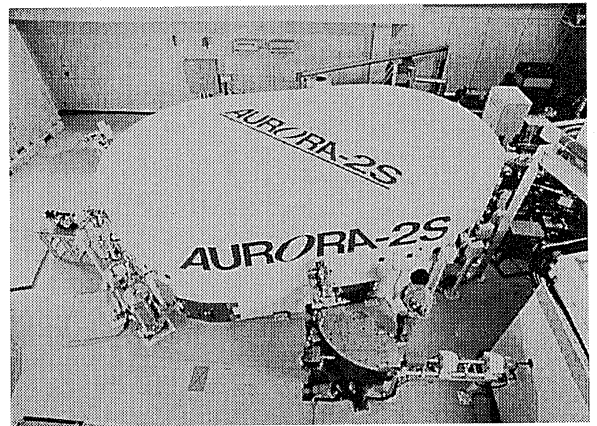

Fig. 1 Overall view of AURORA-2S

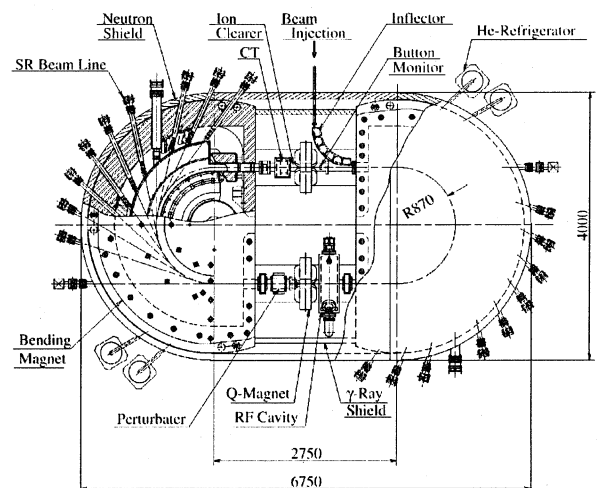

Fig. 2 Schematic view of AURORA-2S

## 2 Beam Test

First we constructed A2D in our laboratory and made a performance test in 1997. After obtaining satisfactory results [4][5], the A2D was reassembled to A2S and the beam test was started from January 1998 with the same method of beam injection, acceleration, and accumulation as used for A2D [4].

In the initial commissioning we found some problems which were serious not for A2D but for A2S. In September 1998, however, we have succeeded in managing such the problems with some reconstruction. The reconstruction was as follows [6][7][8].

- Reinforcement of the tuners in the RF cavity.
- The frequency of the RF was modulated in a series of pulses simultaneously with the excitation of the perturbator.
- Removing the ion clearer.

And then we obtained the following results in Table 2 and the performance of A2S has reached almost full specification [7][8].

Fig. 3 shows the typical excitation pattern of A2S.

Table 2  
RESULT OF BEAMTEST

Maximum injection current	1020 mA
Maximum stored current	>500 mA
Maximum injection speed	640 mA/min
Acceleration efficiency	>80 %

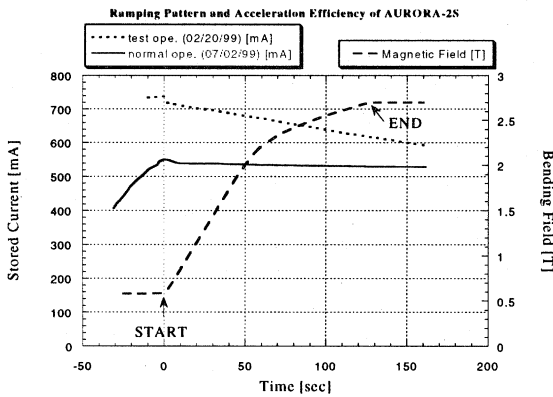

Fig. 3 Typical excitation pattern of AURORA-2S

## 3 Routine Operation

Because the operators are not necessarily experts on accelerators in a routine operation, we made an effort to simplify the operation of the machine before the routine operation.

In February 1999 we made a non-stop-operation of A2S for two weeks (272 hours) with stored current of 500mA. There were no devices damaged or troubled during the test, so we could make sure the high reliability of A2S [8].

In March 1999 lead and polyethylene shield was completed.

After that A2S has been operated routinely. In the

present days A2S supplies the light to the users who investigate the X-ray lithography and they have obtained good results.

In August 1999 the integrated current exceeded 300A.H and the lifetime reached 240min at 500mA.

The relation between the integrated current and the lifetime is shown in Fig.4.

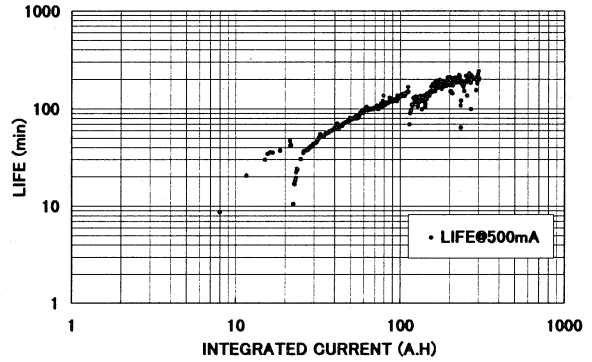

Fig. 4 Integrated current and lifetime

## 4 Plan to Upgrade the Performance

In these days we have faced the problem of the coupled bunch instability caused by the higher order mode electromagnetic field in the RF cavity, therefore we have not been able to inject the beam more than 500mA. Fig. 5 shows the signal from the button position monitor at the moment when the stored beam vanishes in the beam injection. This was observed with the real time spectrum analyzer. In the upper drawing the frequency of the peak is 511.315MHz, and it corresponds to the vertical tune. In the lower drawing the ordinate means the time with 20msec full scale and the darkness of the color means the intensity of the peak. In this figure the peak of 511.315MHz appears only in about 4ms, in other word the injected beam vanishes in 4ms by the coupled bunch instability.

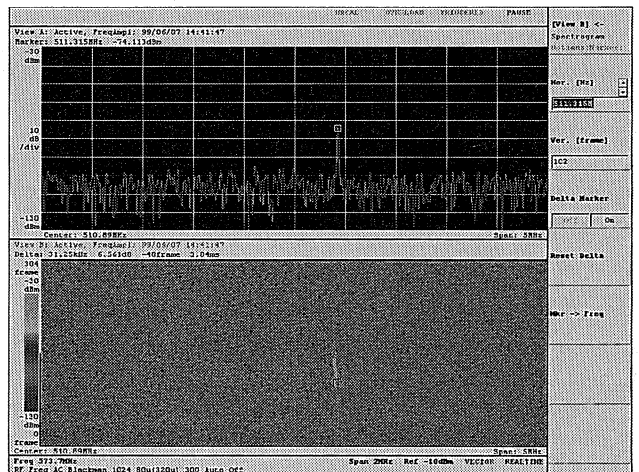

Fig. 5 Signal from BPM at the instability

To diminish the instability we are planning to lengthen

the beam with a Landau cavity whose fundamental frequency is 573.732MHz (3 times higher than the main RF's). The Landau cavity has already been installed in the ring. We will start the test with the Landau cavity from September 1999. Our upgraded goal is 1000mA of stored current at 0.7GeV.

The schematic view and the parameters of the Landau cavity are shown in Fig. 6 and Table 3 respectively.

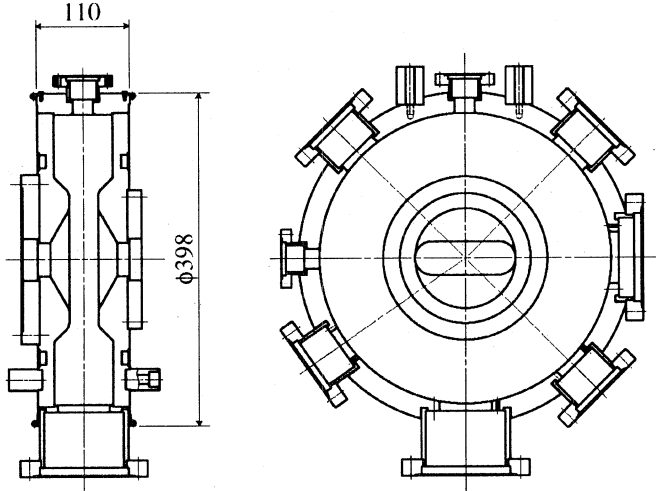

Fig. 6 Schematic view of Landau cavity

Table 3  
PARAMETERS OF LANDAU CAVITY

CAVITY LENGTH	L	8.0	cm
CAVITY DIAMETER	D	34.8	cm
GAP LENGTH	g	3.5	cm
RF FREQUENCY	$f_{rf}$	573.732	MHz
RF VOLTAGE	$V_{max}$	53.3	kV
UNLOADED Q(@80%Q)	$Q_0$	13180	
WALL LOSS(@80%Q)	P	2.2	kW
SHUNT IMPEDANCE	$R_{sh}$	1.157	Mohm
TRANSIT TIME FACTOR	TTF	0.93897	

We have also faced the problem that the saturation is beginning in lengthening the lifetime. Fig. 7 shows the relation between the lifetime and the vacuum pressure in the RF cavity. It appears that the slope becomes dull below  $6 \times 10^{-7}$  Pa in the vacuum pressure. Also in Fig. 4 it appears that the slope becomes dull above 150A.H in the integrated current.

To lengthen the lifetime we are planning to expand the beam size with a skew sextupole magnet. The magnetic field is represented as follows.

$$B_x = k(x^2 - y^2)$$

$$B_y = -2kxy$$

Where  $k$  is an intensity of a skew sextupole magnet, for our magnet  $k=0.1$  kGauss/cm<sup>2</sup>

Under the skew sextupole field the beam expands in size on the resonance of  $2\nu_x - \nu_y = 2$ , and the Touscheck lifetime is expected to be lengthened.

In August 1999 the magnet is under construction and in September 1999 it will be completed and installed in the ring. The test with the skew sextupole magnet will be

started from October 1999. Our upgraded goal is to lengthen the Touscheck lifetime up to 10 hours at 1000mA of stored current.

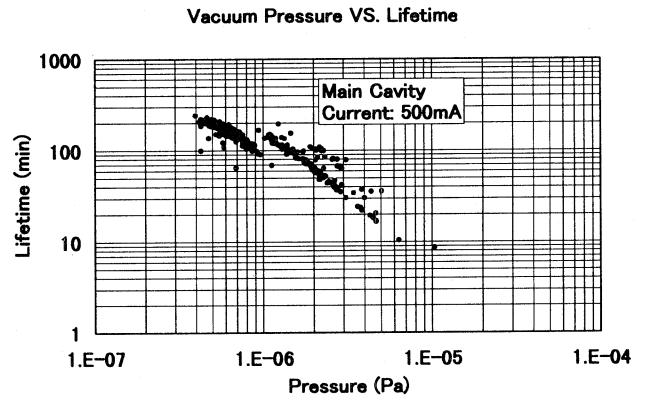

Fig. 7 Relation between the lifetime and the vacuum

### References

- [1] "Rits SR Center Activity Report 1996", Ritsumeikan Univ. (1997) pp. 3-7.
- [2] T. Hori, et al., "AURORA-2: Compact Advanced SR Ring as an X-ray Source", 4th Int'l Conf. On SR sources & 2nd Asian Forum on SR, Kyongju, Korea (1995) pp. 148-158
- [3] K. Yoshida, et al., "Commissioning of a Compact Synchrotron Radiation Source at Hiroshima University", APAC'98, KEK, Tsukuba, Japan, March 23-27 1998
- [4] T. Hori, "Present Status of AURORA-2D", 11th Symposium on Accel. Sci. and Tech., Harima, Japan (1997) pp. 534-536
- [5] T. Hori, et al., "Operation Results of Compact SR ring AURORA-2D with 7Tesla Wiggler", EPAC'98, Stockholm, Sweden (1998) pp. 581-583
- [6] H. Miyade, et al., "Initial Commissioning of Dedicated SR Ring "AURORA-2S" for X-ray Lithography", EPAC'98, Stockholm, Sweden (1998) pp. 2413-2415
- [7] H. Miyade, et al., "Beam Test of Compact SR Ring "AURORA-2S" for X-ray Lithography", 1st Symposium on Accel. and Rel. Tech., Tokyo, Japan (1998) pp. 49-52 (in Japanese)
- [8] H. Miyade, et al., "Beam Test of Compact SR Ring "AURORA-2S" for X-ray Lithography", PAC'99, New York, USA (1999) to be published.