

Design of Magnet Rearrangement and Power Supply for SPring-8 Storage Ring Long Straight Sections

Hideki TAKEBE, Kouji TSUMAKI, Hitoshi TANAKA,
Kouichi SOUTOME, Keiko KUMAGAI, Hiroto YONEHARA, and Noritaka KUMAGAI.

SPring-8 Accelerator Division
Koto 1-1-1, Mikazuki-cho, Hyogo 679-5198, JAPAN

Abstract

In the SPring-8 storage ring, magnet rearrangement for four Long Straight Sections (LSSs) will start from June 2000. A detail design for the power supply (PS) of the Storage Ring (SR) LSSs quadrupole (Q) magnets was started from June 1999. A computer control system for the PSs will be the same as the current system of SPring-8 which is VME and RIO stile. Final design and some considerations are given in this report.

1 Introduction

Some upgrade plans of the SPring-8 storage ring have been discussed from the beginning of the project. Since the first stage performance of the SPring-8 was successfully achieved and user operation has been done steadily for these two years (1997-1999), the next stage project using four LSSs was started in December 1998^[1].

After magnet rearrangement, a drift space of about 27m becomes available for installation of an insertion device. Typical betatron and dispersion functions of the normal cell and LSS are shown in Fig.1 and 2 before and after the rearrangement, respectively. The emittance can be lowered to about 5nmrad. A matching section at each end of the LSS is about 10m. In this section there are six families of Q magnets and the betatron functions and phases are matched as shown in these figures.^[2] In the storage ring, four magnet-free LSSs will be realized keeping four fold symmetry.

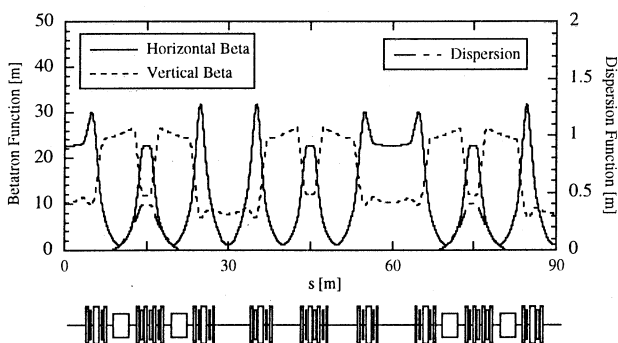

Fig. 1. Betatron and dispersion functions of the magnet-free LSS before magnet rearrangement.

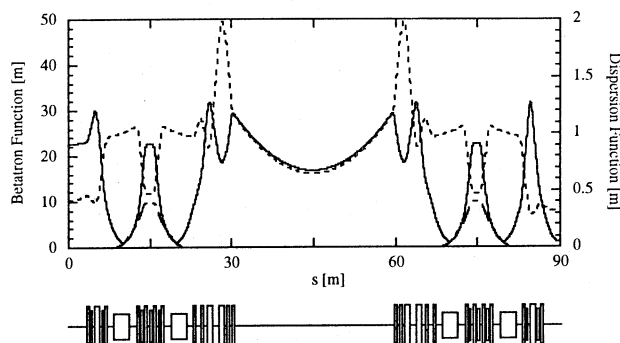

Fig. 2. Betatron and dispersion functions after magnet rearrangement.

The new LSS lattice design was considered with the following limitations : 1) magnets are the same as the used before, 2) Q magnets between two bending magnets in the next upstream and downstream cells are rearranged, 3) the sextupole (S) magnet is not used, and 4) the required field strength and current of the Q magnets are less than before.

Table 1 lists the 6 families of Q-PSs, Q magnets types, currents, resistances, inductances and power consumption and the number of the PSs. The maximum current is 580A. Two magnets are connected in series. So, new six PSs are installed in each A, B, C, D - PS rooms.

Table 1.

PS Name	Mag Type	R mOh	2Mag mH.	PS Volt.	Output kW	Amt No.
QLP1	Q3	19.5	28	30	16.3	4
QLP2	Q5,6	19.5	28	30	16.4	4
QLP3	Q9/Q2	40.4	52	55	31.2	4
QLP4	Q9/Q2	40.4	52	55	31.2	4
QLP5	Q8	19.5	28	30	16.4	4
QLP6	Q7/Q4	16.9	22	30	14.8	4

1 PS Room 108kW 24

2 Rearrangement of the Q-Magnet

The former Q and S magnets in the LSS (cell No.6, 18, 30 and 42) are going to be replaced from June 2000. The Q, S magnets and base girder will be replaced, and cables for

the upper side circular cell-to-cell circuit and lower side magnet-to-terminal soft cables (LMFC) will also be replaced (Fig.3, 4). The other normal cell magnets are connected with the upstream cell and downstream cell magnets (Jumper). Figures 3-a and 3-b show this replacement and connection of the Q magnets, cables and terminals. The new magnet girder is designed with a length of 8 m. Some steering magnets and skew magnets are to be

placed. Base-plates for this girder were already constructed in Summer 1999. A detail design of the LSS magnet girder is shown in Fig.5.

The former interlock system is to be modified for the replacement of the Q and S magnets. The input circuits of the distributed PLC terminals for the LSS magnets are to be closed.

(a) Former LSS Section

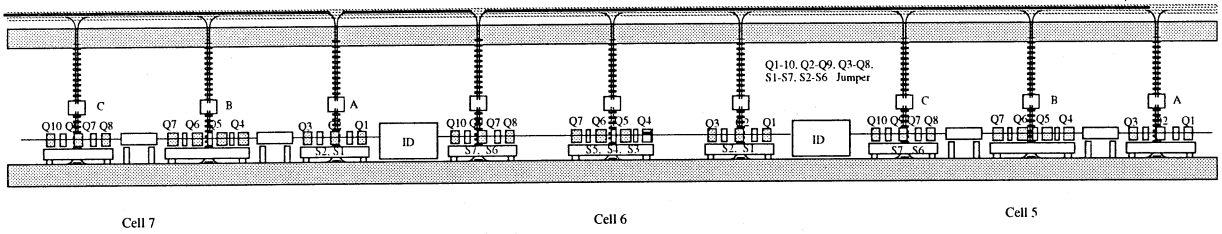

(b) After Removal of Cell 7-A, Cell 6 and Cell 5-C

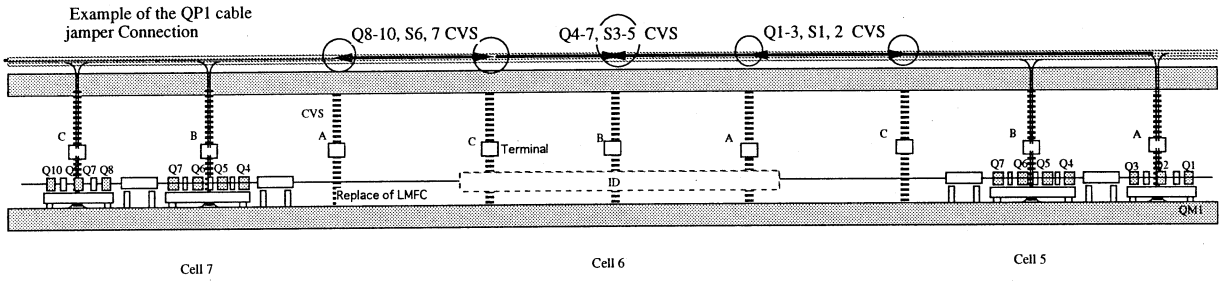

Fig.3 Configurations of present LSS lattice magnets (a) and jumper connection cables after removal of magnets (b).

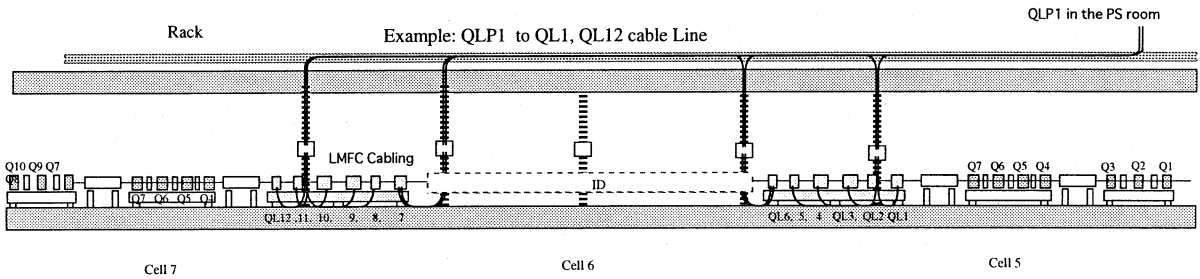

Fig.4. New LSS installation of the Q magnets, girders, cables and terminals.

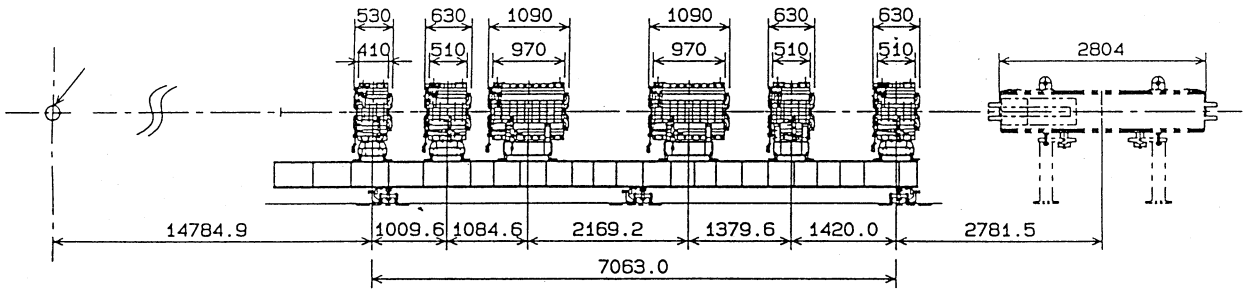

Fig.5. A detail design of the LSS magnet arrangement and girder.

3 Power Supply of the Q-Magnet

The LSS Q-magnets are designed in mirror symmetry. So, two magnets are connected in series (see Table 1). The new six PSs will be settled in each A, B, C, and D - PS rooms. Total number of the LSS Q-PS (QLP) is 24. The six PSs are divided into two groups, 600A 55V type and 600A 30V type. A detail design for the power supply was started from June 1999 with Nichicon Elec. Co., Ltd. A current control and ripple reduction system is used with 20kHz switch mode IGBT module. A current ripple and stability are regulated less than 2×10^{-5} and 5×10^{-5} , respectively. An input voltage is 3 phase AC400 V. The former 40 Q auxiliary PSs for the LSSs will be disconnected, and can be used for a correction of the Q magnet current in the other normal cell. An example of this QLP block diagram is shown in Fig.6.

A computer control system for the PSs is the same as the current system of SPring-8 which is VME and RIO optical-fiber linked field BUS system.^[3] An RIO Master card will be installed in the A, B, C, and D PS room's VME chassis.

The QLPs take an air cooling system. The magnet water flow switch and coil temperature switches are to connect to the PS interlock input, directly. The former B,Q,S PSs are used with a PLC interlock system, but the LSS Q PS takes a direct wire connection system. PS status bits to the RIO slave card (for the magnet interlock input) are slightly changed.

References

- [1] H. Tanaka et al., "Design of SPring-8 Storage Ring with Four Magnet-Free Long Straight Sections", SPring-8 Ann.Rep.(to be published), (1998).
- [2] H. Tanaka, K. Soutome, and M. Hara, J. Synchrotron Rad. 4,47(1997).
- [3] H. Takebe et al., "Magnet Power Supply Control System for the SPring-8 Storage Ring", Presented at the 4th EPAC, London, GB. 1827-1829, (1994).

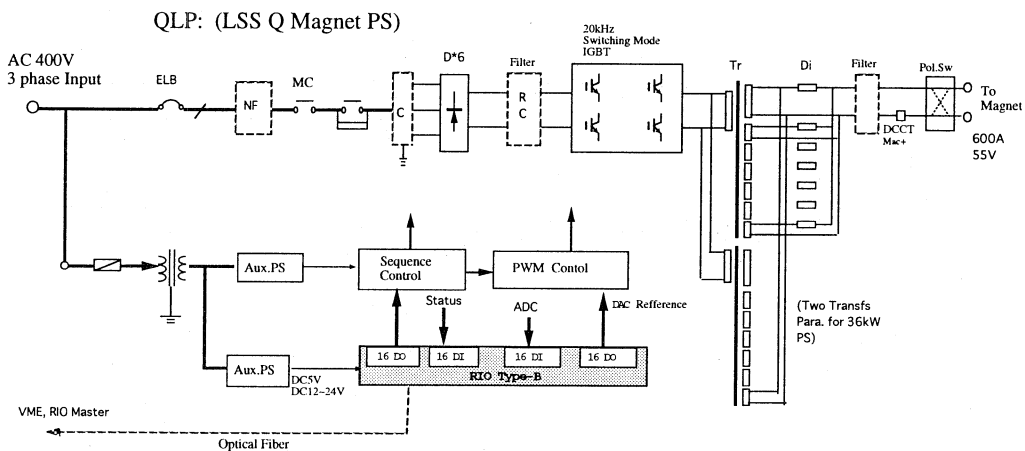

Fig.6. QLP circuit block diagram.