

Stability study of ATF 80MeV injector linac

T. Naito, H. Hayano, H. Matsumoto, J. Urakawa,
M. Ross*, K. Jobe*, D. McComick*

KEK, National Laboratory for High Energy Physics,
1-1 Oho, Tsukuba-shi, Ibaraki-ken, 305 Japan
*Stanford Linear Accelerator Center(SLAC),
Stanford, California 94309, USA

Abstract

A beam stability test was carried out at ATF 80MeV injector linac. The test was performed by taking data of each monitor in pulse to pulse base. A data acquisition system which consists of a PC and a GPIB network was used for the test. In order to analyze the data, 'Correlation plot' method is used which is effective to find out some source of the observed the beam fluctuation. This paper describes the result of the stability measurement and the comparison between ATF injector and SLC injector.

1. Introduction

The Accelerator Test Facility(ATF) consists of a 1.5 GeV linac and a damping ring which is under construction in KEK.¹⁾ The purpose of the ATF is development of accelerator components to realize future Linear Collider. The injector part of the linac consists of a thermionic gun, two SHBs(357MHz), seven cells of buncher following to a 3m long S-band(2856MHz) accelerating structure(AS). The energy of beam is 80MeV at the exit of the AS when 60MW of RF power is fed into the AS. The diagnostics of the injector are an amorphous core current transformer(CT), an integrated current transformer (ICT), wall current monitors(WCMs), beam position monitors(BPMs), florescent screen profile monitors(PRM) which measure the beam size and the relative position, optical transition radiation monitors(OTRMs) which measure a bunch by bunch beam profile using a fast gate camera and a bunch

length using a streak camera and a photo-multiplier(PMT) with a scintillator which measure a beam loss.

In order to produce a stable beam at the injector is a key issue for a stable operation of ATF. 4% of the fluctuation of beam intensity at the injector is measured which should be reduce to less than 1%. In order to investigate a source of the fluctuation, the test was performed by acquiring the pulse to pulse data from each monitors in each position. The data acquisition system consist of a PC and a GPIB network which connect between the PC and the data acquisition devices. The acquired data are treated statistically and analyzed by 'Correlation plot'. The correlation coefficient which is evaluated in the correlation plot exhibits a strength of connection between the two measured quantities. This technique is used at SLC beam tuning.²⁾

2. Data acquisition system

System configuration

The configuration of the data acquisition system is shown in Fig. 1. Two scopes for electrical pick up signals, a streak camera for bunch length measurement and a pulse generator for generating a system trigger signal, are connected to a PC through a GPIB network. A video analyzer for the energy and the energy spread measurement at PRM4 not yet have the interface software. The beam trigger signal starts the beam emission of the electron gun which is distributed to each acquisition device as the acquisition trigger signal in order to acquire at same

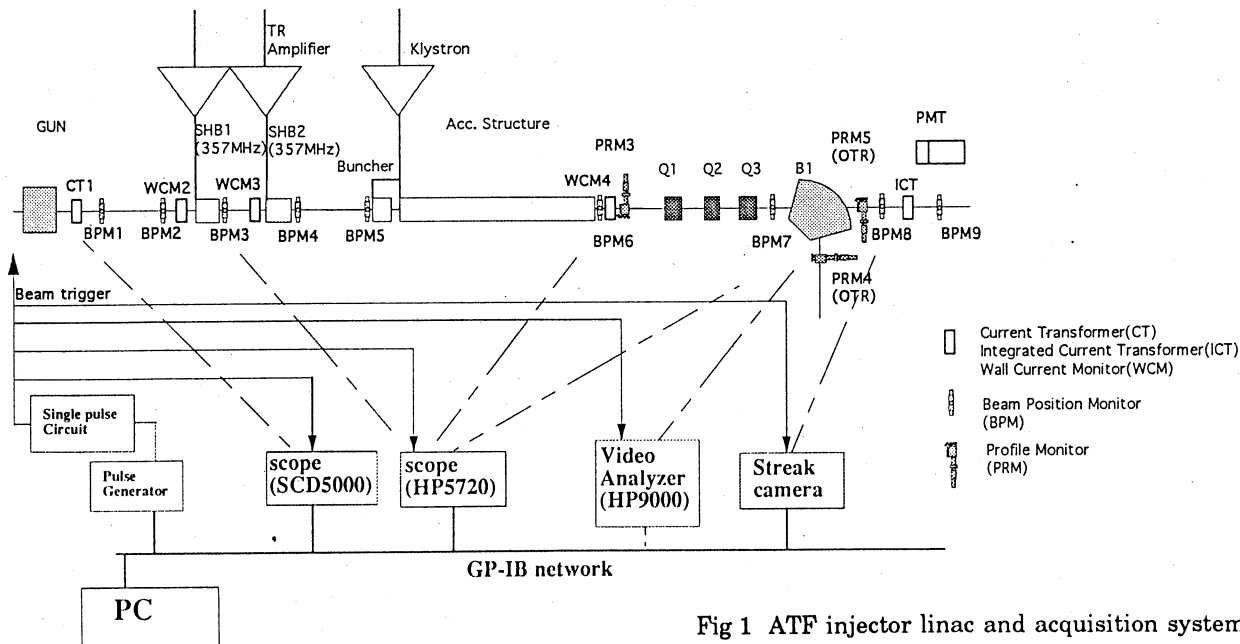

Fig 1 ATF injector linac and acquisition system

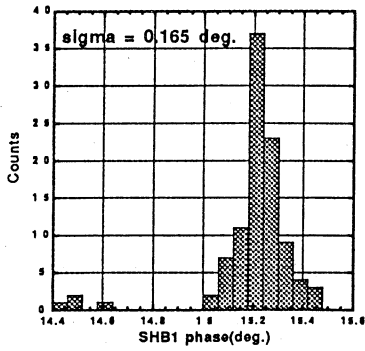

Fig. 2a) SHB1 ϕ distribution

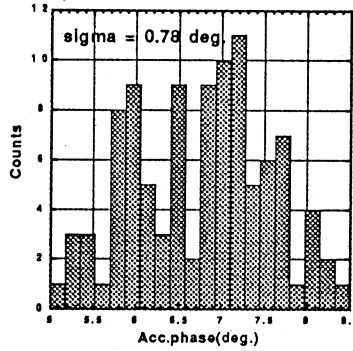

Fig. 2b) AS ϕ distribution

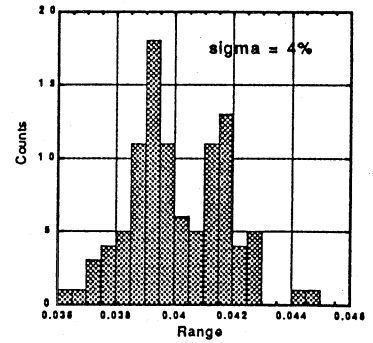

Fig. 2c) Beam intensity distribution

timing. The acquisition sequence is following, the pulse generator generates a single pulse for the system trigger by the software, the other devices acquire each points of monitors at same timing, the acquired data are recorded to the PC and then the pulse generator generates a next single pulse for next data acquisition. For each test, 100 data are recorded and used for the analysis. The acquisition speed was 5-10 sec. per data. The size of data was 10k-20kbytes per data. The software used in this system are VEE for the GPIB control and MATLAB for the data processing and analysis.

Monitoring beam signals

Following signals were used for the test.

- a) Gun high voltage: The gun use a pulsed high voltage of 3 μ sec which is made by a PFN and a thyatron circuit. The fluctuation of this voltage will affect to the beam intensity and the beam optics directly.
- b) Beam intensity : The CT and the WCMs measure the micro-pulse of beam intensity. The ICT measure the total beam intensity of multi-bunch.
- c) Beam loss: The PMT detects the beam loss at the down stream of the accelerating structure.
- d) Beam position: The signals from BPMs are stretched by the head amplifiers and recorded its wave forms. The beam position are calculated by using the peak amplitudes which are estimated by polynomial fittings for the sample hold points of the scope. The sum of the opposing electrode signals is proportional to the beam intensity approximately.

- e) RF phase: The RF phases of two SHBs and a AS are measured by a mixer at the output level of ϕ -crossing.
- f) Beam energy and energy spread: The PRM4(OTR) is located after a 90 degree bending magnet. The horizontal position and width of the profile show the beam energy and the energy spread. The video analyzer acquires the video signal and calculates the projection of the profile. 3)
- g) Bunch length: The light from the PRM5(OTR) is fed to feed to a streak camera. 4) The bunch length is measured by the projection of the swept image of the light.

3. Result

The beam parameter for the test were following, beam mode: single bunch, charge number $\sim 1.5 \times 10^{10}$ electrons, beam energy: 80 MeV. None of machine parameters were changed during each test.

Signal distribution

The examples of the signal distribution are shown in Fig.2. Fig.2a), b), c) show the distribution of RF phase of SHB1(SHB1 ϕ), RF phase of AS(AS ϕ) and beam intensity by ICT, respectively. The sigma values of the fitted gaussian distribution were SHB1 ϕ : 0.16deg., AS ϕ : 0.78deg., ICT: 4%. Some data points which were deviated from the main distribution were observed in the phase distribution of SHB1. It's assumed to the possibility of discharge at inside of the

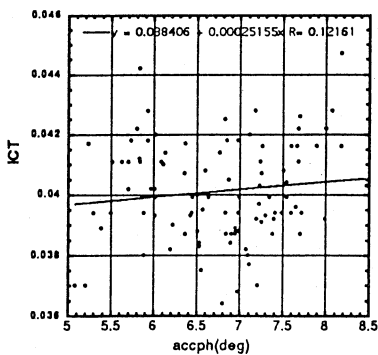

Fig. 3a) AS ϕ -ICT correlation

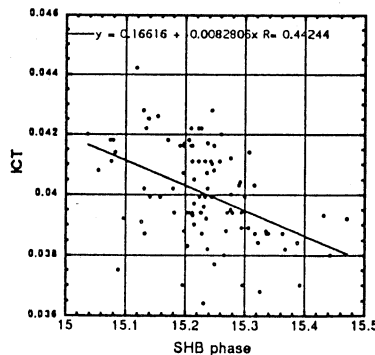

Fig. 3b) SHB ϕ -ICT correlation

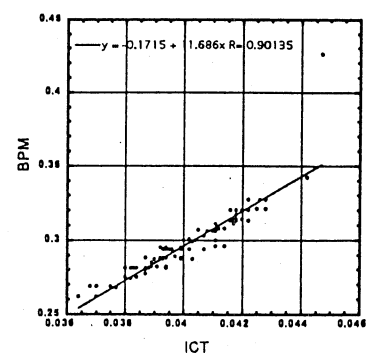

Fig. 3c) ICT-BPMsingle correlation

cavity.

Correlation plot

The examples of the correlation plot are shown in Fig.3. Fig.3a), b), c) show the correlation plot of AS ϕ -ICT, SHB1 ϕ -ICT and ICT-BPMsingle signal. The correlation coefficients were 0.12, 0.40 and 0.90, respectively. A correlation of 0.2 or lower is hard to find out the causality. Correlation of 0.3 or more are assumed to be the causality between two observed quantities. In the case of Fig.3c), the beam intensity monitored two different monitors exhibits a strong correlation.

Same measurement were repeated for each signals. The result are summarized in table 1 and 2. The tables are presented in the form of correlation coefficients matrix with one-sigma of the distribution in the diagonal. In the table 1, correlation can be seen between SHB2 ϕ -BPMposition and SHB2 ϕ -BPMsum. No other correlation except for between the same physical value. It's assumed that the change of the RF phase of SHB2 affect to the beam position and the intensity.

4. Summary

The stability of ATF injector is compared to the stability of SLC injector in table 3. The ATF data is two times to several times lager than the SLC data. The one of reason come from the noise from klystron modulator. The small correlation coefficient was observed even between two current monitors that is a

evidence of the noise effect. The noise cure is significant problem to realize the stable beam at ATF.

The unexpected distribution of RF phase of SHBs were observed in the result. The fluctuations were assumed to be correlated to the beam current and the position. The after the test, we could find the evidence of the discharge at the vacuum shield ceramics of the couplers when open the cavities.

5. Acknowledgment

This study was executed in a framework of an exchange program of SLAC and KEK collaboration. We would like to express our thanks to Professors Y.Kimura and K.Takata for their encouragement. We also thank other members of ATF group and Mr. S.Morita of ATC Corporation for their support.

6. References

- 1) F.Hinode et al, "ATF Design and Study Report", KEK Internal 95-4, June1995
- 2) L.Hendricson et al, "Correlation plot Facility in the SLC Control System", SLAC-PUB-5464 May 1991
- 3) T.Naito et al, "Bunch by bunch beam monitor for ATF injector linac", Proc. of the 17th International Linac conference, Aug. 1994, KEK 94-102(1994)
- 4) H.Hayano et al, "An 80MeV Injector for ATF Linac", Proc. of the 17th International Linac conference, Aug. 1994, KEK 94-110(1994)

Table1. example of correlation coefficients and one-sigma distribution. (SHB2 ϕ , BPMs, streak camera)

	SHB2 phase	BPM8 pos	BPM8 sum	BPM9' single port	Streak sig	Streak integ.
SHB2 ϕ	.06deg					
BPM8 position	.34	94 μ m				
BPM8 sum	-.21	-.67	0.8%			
BPM9' single	-.33	-.86	.86	1.7%		
Streak sigma width	.06	.17	-.09	-.12	14%	
Streak integration.	.10	.02	-.05	-.01	-.62	15%

Table1. example of correlation coefficients and one-sigma distribution. (AS ϕ , SHB1 ϕ , WCM, BPM, E, dE/E)

	AS phase	SHB1 phase	WCM4	BPM6 single port	Energy	dE/E
AS ϕ	.47deg					
SHB1 ϕ	0.06	0.11deg.				
WCM4	0.079	0.068	2.3%			
BPM6 single port	0.094	0.25	0.11	2.9%		
Energy	0.095	0.077	0.015	0.044	0.086%	
dE/E	0.017	0.057	0.21	0.092	0.1	13%

Table3 comparison of the stability of each components of ATF and SLC

	AS phase	SHB1 phase	SHB2 phase	Gun HV	BPM x	BPM sum
ATF	0.5-2 deg	0.16-0.4deg	0.11 deg	0.07%	20-100 μ m	1%
SLC	.07deg	0.02 deg	0.03 deg	0.01%DC	15 μ m	0.5%