

Influence of External Magnetic Field on Beam DCCT

M. Sugiura, M. Yuasa*, T. Kasuga† and M. Tobiyama†
 Faculty of Science, Hiroshima University, Higashi-Hiroshima 724, Japan

Abstract

Influence of the external magnetic field on a beam DCCT has been examined. Although the magnetic field does not affect the linearity and the sensitivity of the DCCT, it disturbs the output offset voltage. The cause of the disturbance was carefully investigated. It was found that the nonuniform winding of the DCCT does not cause the offset but it results from nonuniformity of the magnetic properties of cores. A simple method to reduce the disturbance was successfully tried.

1 Introduction

A beam DCCT (dc current transformer) is used to measure the circulating beam current in an accelerator. The principle of the DCCT is as follows: the DCCT consists of two magnetic cores which have a steep hysteresis loop and three windings on them. A sinusoidal excitation current through one of these coils saturates the cores, and pulses appear in the second coil when the magnetic field by the excitation current crosses the steep step of the hysteresis loop. When the beam passes through the cores, the induced dc field is superposed on the sinusoidal field and the phase difference between the pulses and the sinusoidal excitation current changes. The third coil is used to correct the phase change with feedback technique. If the feedback loop gain is sufficiently large and the correction is perfect, the feedback dc current is equal to the beam current (divided by the turn number of the coil.). Therefore, we obtain the beam current measuring the feedback current.

In many accelerators, DCCTs are placed near electromagnets. Accordingly, it is important to investigate effects of the leakage magnetic field on the DCCT. If a DCCT has round cores with uniform magnetic properties and uniform windings, it cannot be affected by the uniform external magnetic field because the effects of the external field are cancelled out around the core ($\text{rot}B_{ext}=0, \text{rot}B_{beam} \neq 0$). However, it is wellknown that the output of the DCCT is affected by the leakage magnetic field.

*Present address: Yutakagaoka High School, Tyohashi 440, Japan

†Present address: National Laboratory for High Energy Physics, Tsukuba 305, Japan

We measured the effects of the external magnetic field on the DCCT output quantitatively. We also investigated the cause of these effects, and tried a simple method to reduce them.

2 Setup

A block diagram of the DCCT is shown in Fig.1. The system consists of an oscillator ($f=270\text{Hz}$), a frequency doubler, a phase shifter, a band-pass-filter (BPF, $f_c=540\text{Hz}$), a demodulator and an integrator. The oscillator sends a reference signal to the excitation winding and the frequency doubler. The frequency doubler (AD 533) doubles the reference signal and feed to the demodulator through the BPF.

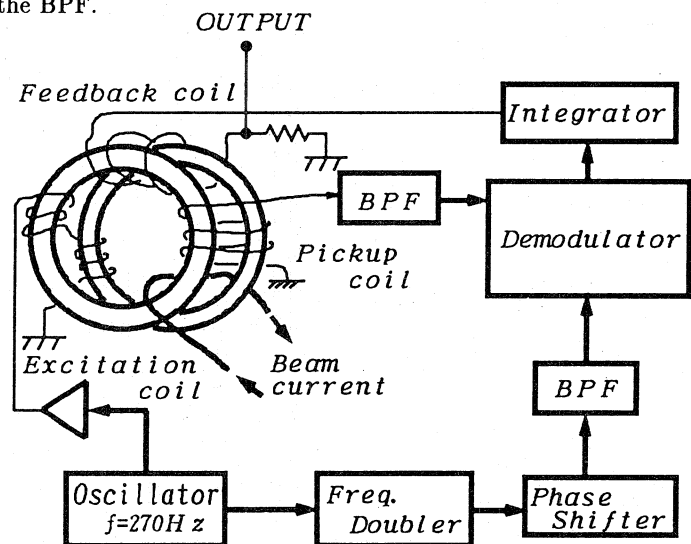

Fig. 1: Block diagram of DCCT system

The DCCT core consists of two toroidal cores; wound strips of a high permeability Ni-Fe alloy (Tokin, N-214S). The two toroidal cores have an excitation winding (40 or 50 turns), a pick-up winding and a feedback winding (40 turns). The two cores were wound with the excitation winding in opposite direction. We use a Helmholtz coil with a center distance of 23.8 cm in order to generate the magnetic field. The direction of the axis is paralleled to

the terrestrial magnetic field.

3 Experimental

A linearity between the beam current I_b and the DCCT output I_o is shown in Fig.2. In this figure, these lines corresponding to the external field of 1.07×10^{-4} (T), 1.79×10^{-4} (T), and the terrestrial field, respectively. Linearity is sufficient if we neglect the offset due to the external field.

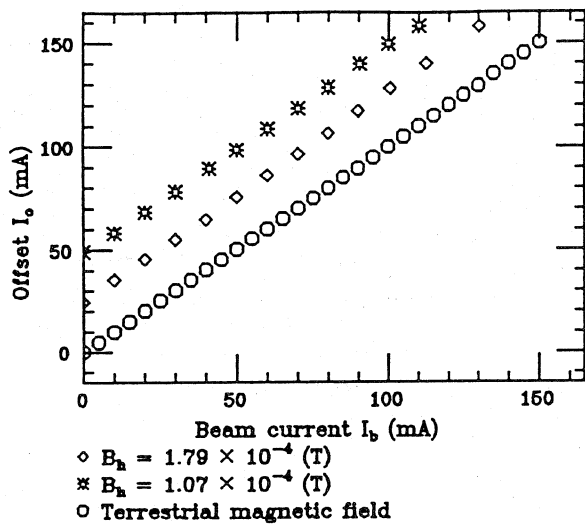

Fig. 2: The linearity of the DCCT.

The output voltage was measured as a function of the angle θ between a certain axis of symmetry on the plane of the DCCT core and the direction of the terrestrial magnetic field. Results are shown in Fig.3. Some asymmetry in the DCCT system is suspected.

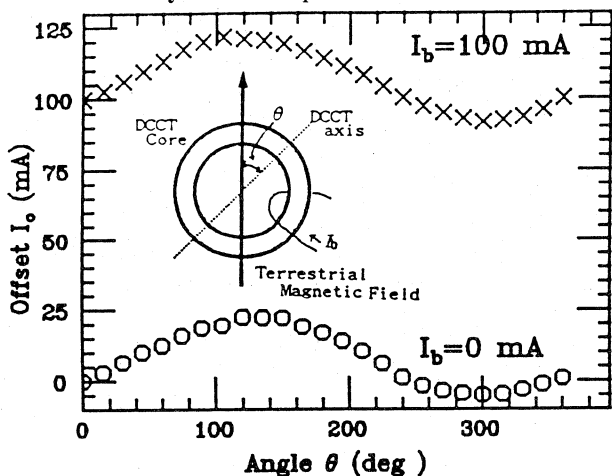

Fig. 3: DCCT offset vs angle θ between DCCT axis and terrestrial magnetic field.

One of possible causes of the asymmetry is the uniformity of the windings. We wound the pick-up winding locally on the core and made the same experiment to

check this assumption. However, no obvious change was obtained.

The other possibility is local magnetic imperfection in the cores. To check this possibility, we observed the local B-H curve by using a local excitation and pick-up windings as shown in Fig.4.

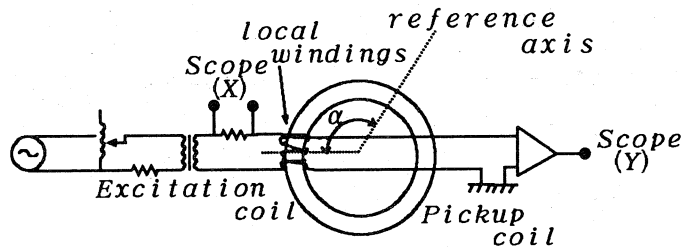

Fig. 4: Measurement system of local B-H curve.

An example of the results is shown in Fig.5. Fluctuation of the saturated magnetic flux in the core is observed. The saturated magnetic flux ϕ (see Fig.5) was measured as a function of the azimuthal position α in the core. The results for the two cores used in the DCCT are shown in Fig.6. We changed the cores for new ones, however, improvement of the output offset was not satisfactory.

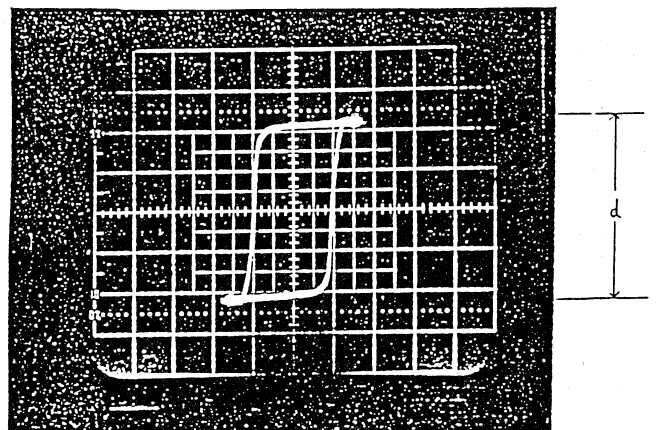

Fig. 5: B-H curve.

Therefore, we concluded that the imperfection had already existed when the cores were shipped.

In order to check the influence of the imperfection, we fixed the magnetically imperfect parts of the cores (A and B in Fig.6) and measured the offset due to the external magnetic field. Examples of the measurement are shown in Fig.7. As shown in this figure, when the angle α between the lines of symmetry of the core 1 and core 2 is 180° , the offset due to the external field is large. However, it is improved down to about a tenth if the angle α is set to be 35° .

4 Shielding

The effect of the magnetic shielding with the same material as that of the cores is shown in Fig.8. The offset due to the external field decreases down to about a tenth of that without the shielding.

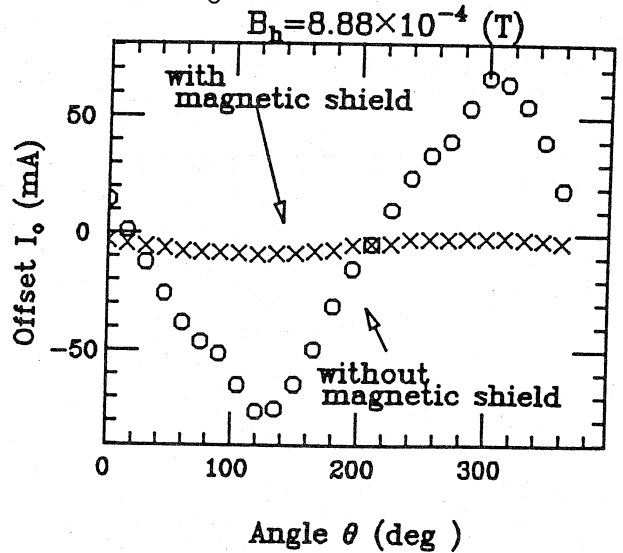

Fig. 8: Effectiveness of Shielding.

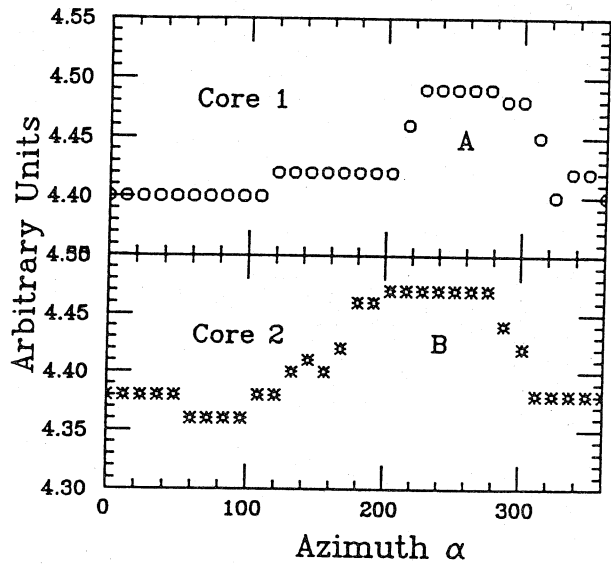

Fig. 6: Local saturated magnetic field in magnetic core.

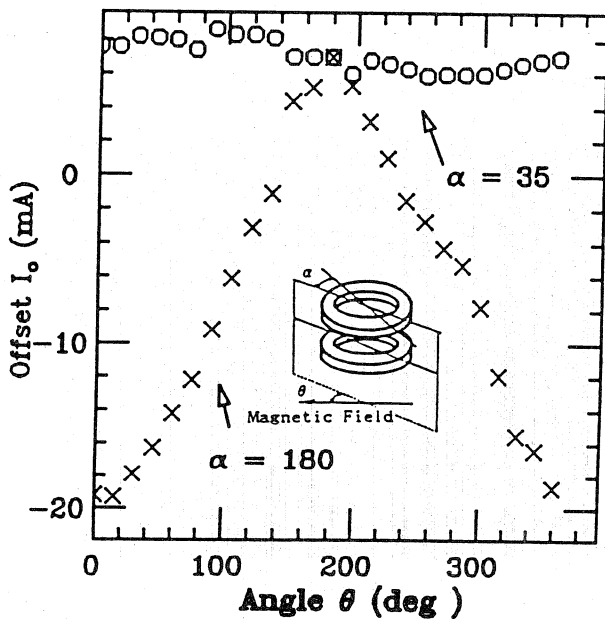

Fig. 7: Improvement of output offset.

5 Summary

We found that the output offset of the DCCT due to the external magnetic field is not caused by the nonuniform windings of the DCCT but caused by the imperfection of the magnetic material of the cores. If the two cores are arranged properly, the offset can be largely improved. The shielding with magnetic materials is also effective. To select a matched pair of cores and to arrange them properly are important to make the DCCT which is insensitive to the external magnetic field.

The authors thanks to Mr.T.Nagaoka for his previous work.

References

- [1] K. Unser, IEEE Trans. NS-28 (1981) p2334.
- [2] K. Unser, IEEE Trans. NS-16 (1969) p934.