

ELECTRON LINEAR ACCELERATOR BASED ON THE $V_p \times B$ ACCELERATION SCHEME

Yasushi Nishida and Hiroshi Onihashi
 Department of Electrical Engineering, Utsunomiya University
 Utsunomiya, Tochigi 321, Japan

ABSTRACT

It is revealed in the microwave-plasma interaction experiments that the large amplitude electrostatic wave propagating obliquely to a magnetic field accelerates electrons strongly almost along the magnetic field lines via the process of $V_p \times B$ acceleration. A new linear accelerator is introduced by use of a TM-mode slow wave structure based on the $V_p \times B$ acceleration scheme.

INTRODUCTION

In order for obtaining a high gradient field in an accelerator, several new concepts of the plasma based accelerator have been proposed. A beat wave accelerator (BWA)[1] which uses a nonlinear optical mixing of two laser beams is successfully proposed of its existence of principle in an arc plasma or a laser produced plasma[2,3]. The observed field gradient is estimated as about 100 MV/m, although the theoretical field gradient of 1.5 GV/m is estimated, where a wave amplitude is assumed to be 5%. Another concept of particle acceleration is a $V_p \times B$ acceleration scheme[4-6], in which the particles are accelerated along the wavefront and across the static magnetic field applied externally. The proof of the existence of this phenomenon has been performed only in a microwave-plasma interaction experiment[4,5], and therefore, the field gradient observed so far is weak of about 20 kV/m or less.

In this paper, we would like to present the experimental confirmation of the $V_p \times B$ acceleration phenomena performed in the microwave-plasma interaction experiments and also a proto-type accelerator design based on a $V_p \times B$ acceleration scheme[7], which could be realized without plasma, although the expected maximum field gradient would be smaller than in a plasma.

Before showing the experimental results, it is convenient to explain a model of the $V_p \times B$ acceleration scheme (v_p : phase velocity of the electrostatic wave). Let us assume there is a weak steady magnetic field, B_0 , across which an electrostatic wave accompanying trapped electrons in its wave troughs travels obliquely to the magnetic field which should appear as $B = B_0 \sin \theta$ in the $V_p \times B$ acceleration mechanism [See Fig.1]. As the magnetic field has the component $B_z = B_0 \cos \theta$, the electron can also be accelerated in the direction $(-e)v_p \times B_z = A_x$ (x direction) in addition to $A_y = (-e)v_p \times B_0$

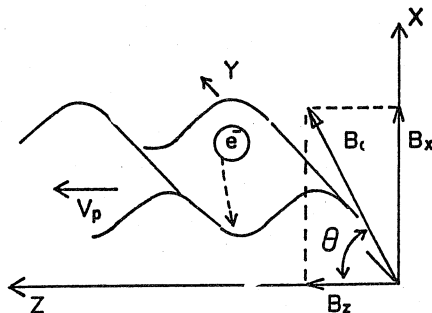

Fig.1. $V_p \times B$ acceleration scheme.

B_x via the process of the $V_p \times B$ acceleration. The A_x component is almost along the magnetic field lines, as long as θ is close to $\pi/2$. As a result, the electron is accelerated three dimensionally, and the maximum velocity v_m in the x direction could become $2V_p$, where $V_p = E/B_0$ is the maximum velocity of an electron accelerated in the y direction at $\theta = \pi/2$. From the equation of motion for an electron in such a situation (here, we restrict our discussions on accelerating an electron, but this kind of model is also applicable to accelerate an ion), we obtain

$$v_x(t) = 2U \sin^2(\omega_{cz}t/2), \quad (1)$$

$$v_y(t) = -U \sin(\omega_{cz}t), \quad (2)$$

where $U = (\omega_{cx}/\omega_{cz})v_p = (B_x/B_0)v_p$ are the amplitude of v_y . Hence, if the relation

$$E > UB_x = v_p B_x^2/B_z \quad (3)$$

holds, Initially Deeply Trapped Particle (IDTP) never detrap from the wave potential. At some angle $\theta = \theta_c$,

$$V_E = v_p \sin^2 \theta_c / \cos \theta_c \quad (4)$$

is attained. Hence, when $0 < \theta < \theta_c$, v_x and v_y have maximum value $V_x = V_{xm} = 2U$ and $V_y = V_{ym} = U$ as seen in Eqs.(1) and (2).

When $\pi/2 > \theta > \theta_c$, IDTP will detrap after an appreciable acceleration since the condition (3) breaks. For a special case of $\theta = \pi/2$, which would be convenient to realize an accelerator based on the $V_p \times B$ acceleration scheme as will be shown later, $v_z = 0$ and a maximum velocity of electron is given as

$$V_{ym} = (eE/m)\omega_c = E/B_0, \quad (5)$$

which is attained at the time $t = (E/B_0)/\omega_c v_p = t_a$, the acceleration time. Therefore, the maximum energy of the electron is shown to be

$$\epsilon = (1/2) m \{ (E/B_0)^2 + v_p^2 \} \quad (6)$$

for a non-relativistic case and

$$d\gamma/dy = \gamma_p a k_p, \quad d\gamma/dz = a k_p \quad (7)$$

for a relativistic case, where $\gamma = (1 - (v/c)^2)^{-1/2}$, $\gamma_p = (1 - (v_p/c)^2)^{-1/2}$ and usually $\gamma_p \gg 1$ and a is the wave amplitude (~ 0.1). The field gradient is also obtained as

$$G = amc \omega_p (1 + \gamma_p^2)^{1/2}. \quad (8)$$

As for sample parameters for 1 TeV linear accelerator, we can obtain $\Delta\gamma = 2 \times 10^6$, $a = 0.2$, $\lambda_0 = 0.35$ (μm), $\Delta y = 56$ cm, $\Delta z = 1670$ (cm), $n = 10^{19}$ (cm^{-3}), $B_0 = 68$ kG and $\gamma_p = 30$.

In the present paper we show the experimental results on the $V_p \times B$ acceleration with obliquely propagating waves to the magnetic field lines ($\theta \neq \pi/2$). However, the case of $\theta = \pi/2$ has been published elsewhere[5,6].

EXPERIMENTAL APPARATUS

The experiments are performed with a cylindrical, nonuniform plasma produced in a chamber of 1 m length by 60 cm diameter covered with multidipole magnets. The precise explanations of the experimental apparatus and typical parameters were given elsewhere[6,9].

A weak magnetic field, less than 11 G, is applied vertically (x-direction) including regions of the present experiments. The magnetic field is made a weak mirror, the center of which locates at $z \sim 28$ cm measured from the edge of the horn antenna for the microwave irradiation [see Fig.2].

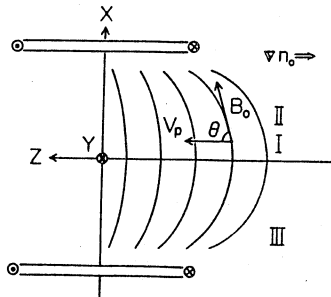

Fig.2. Schematic description of the oblique propagation of ES wave with angle θ to the magnetic field lines.

The p-polarized electromagnetic wave (EM wave) with frequency $f = (\omega/2\pi) = 2.86$ GHz and maximum power 11 kW is launched along the chamber axis from a high gain horn antenna located at the lower density end of the chamber. The EM wave is reflected back at the reflection layer with electron density $n_r = n_c \cos^2 \alpha$, and it excites the electron plasma wave (ES wave) around the critical layer n_c ($\omega = \omega_{pe}$). The ES wave with (ω, k_x) propagates down the density gradient, and its wave front is almost in parallel to the equidensity line. When we shift up the critical layer along the z-axis, the propagation direction θ between k_x and B can be changed through $20^\circ \leq \theta \leq 90^\circ$ (in the $x \neq 0$ area), because of the bending of the magnetic field lines [see Fig.2], while the magnetic field strength does not change in the y-direction within our experimental area.

EXPERIMENTAL RESULTS AND DISCUSSIONS

An example of accelerated high energy electron flux with energy over 60 eV shot out in the x direction is shown in Fig.3 to have dependence on propagation angle θ . Here, the experimental data of the high energy electron flux I_{ex}^m is assumed to be in proportion to v_x , and I_{ex}^m is estimated by the use of the calculated spatial profile of the magnetic field such as schematically shown in Fig.2. From this figure, we can obtain the optimum angle θ_c . Therefore, it is possible to depict the dependence of θ_c on the rf power as shown in the inset of Fig.3.

In order to interpret the experimental results, we have used the theory based on the model of IDTP[8]. By use of Eqs.(1) and (4), numerical results for $\theta_c = 81 \sim 84^\circ$ are obtained as shown by a solid line in Fig.3. In the present experiment, the maximum acceleration length in the x-direction is restricted to less than about 4-5 cm because of the detector systems. Therefore, we could use the acceleration time $\sim 1/\omega_c$ in calculating the theoretical value v_x . The acceleration length would exceed the present system when $65 \sim 70^\circ \leq \theta \leq 90^\circ$ in

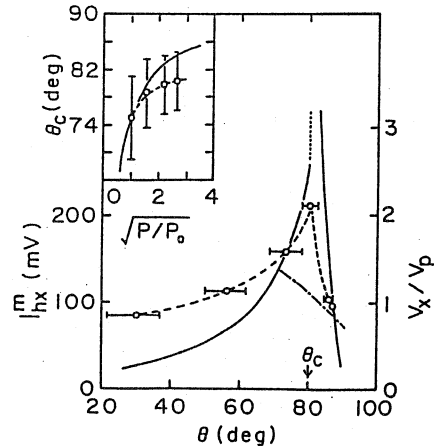

Fig.3. High energy electron flux, I_{ex}^m (open circles) and calculated value of v_x (solid and dot-dash line) vs. the propagation angle θ . $P = 4.8$ kW. Inset shows the optimum angle θ_c vs. the square root of rf power normalized by $P_0 = 1$ kW at $B_0 = -5$ G. Solid line in the inset shows the results of Eq.(4).

Fig.3, while for $\theta \leq 60^\circ$ maximum value of v_x can be expected within this acceleration time $\sim 1/\omega_c$. In calculating the velocity v_x in the range $70^\circ \leq \theta \leq 90^\circ$, we may use the constant acceleration length $x \sim 5$ cm, and the result is shown in the same figure by a dot-dash line, showing reasonable agreement with the theoretical result.

The optimum angle θ_c is also calculated as a function of electric field strength. The angle θ_c is given in Eq.(4). The result is shown in the inset of Fig.3 by a solid line obtained with our parameters. Here, both of the results of experiments and theory are adjusted at $\{P/P_0\}^{1/2} = 1.0$ after assuming that the electric field strength of ES wave is in proportion to the square root of the incident power of EM wave.

Most of the observed characteristics are well interpreted by the theoretical prediction of Sugihara et al[8].

NEW ACCELERATION SCHEME BASED ON THE $v_p \times B$ ACCELERATION

In this section, we would like to show the new accelerator scheme based on the $V_p \times B$ acceleration principle. As there are some problems in the accelerator using the plasma, specifically reliability and stability problems, we want to use the vacuum system (i.e. without plasma) for realizing the accelerator, still keeping the $V_p \times B$ acceleration principle. Therefore, the maximum attainable field gradient is weaker than in the system based on the plasma.

The linear accelerator consists of a slow wave structure and a static magnetic field applied vertically as shown in Fig.4. In this

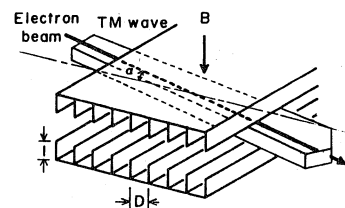

Fig.4. Example of the slow-wave structure type accelerator.

scheme we use the perpendicular propagation $\theta = \pi/2$ of the TM-mode microwave ($f = 2.45$ GHz). The whole system of the experimental apparatus under construction is shown in Fig.5. The main purpose of the present experiment is the proof of principle of the $V \times B$ acceleration scheme in a vacuum system. Therefore, the interaction section of the wave and an electron beam is short as shown in Table 1 with other parameters of the present accelerator.

In the slow wave structure, the field components for dominant mode can be calculated, and an example of the field distribution is shown in Fig.6 for E_x , E_z and H_x components. As easily seen from the figure, the H_x component is weak enough in the region where the electrons are trapped in a wave trough, no major effect on the static magnetic field B_0 .

The phase stability of the trapped particle in a wave frame is also investigated. When there is no magnetic field, the phase of the trapped particle once delays and then advances against the wave by gaining the energy and finally the electron detraps (see Fig.7). If the $V \times B$ scheme is constructed, however, the phase ψ of the particle is stabilized within about $\pm 5^\circ$, and the detrapping never occurs.

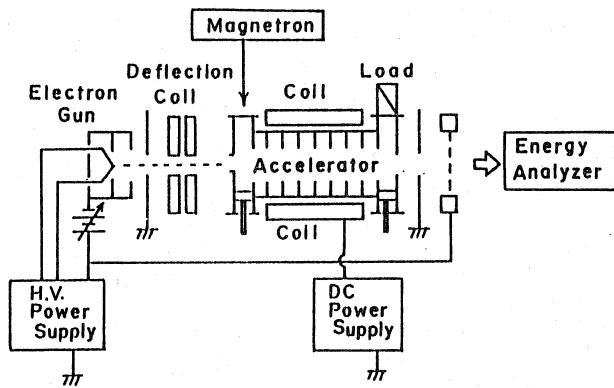

Fig.5. Set-up of the linear accelerator.

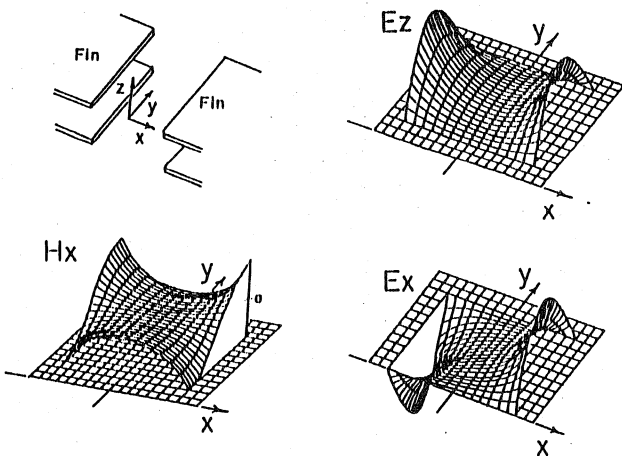

Fig.6. An example of the field distribution.

Table 1. Design parameters

Initial velocity (v_0/c)	V_p/c	Injection angle	B_0 (G)	Gain(keV)	Z(m)	E_z
0.448	0.464	9°	5.3	8.08	0.48	20kV/m

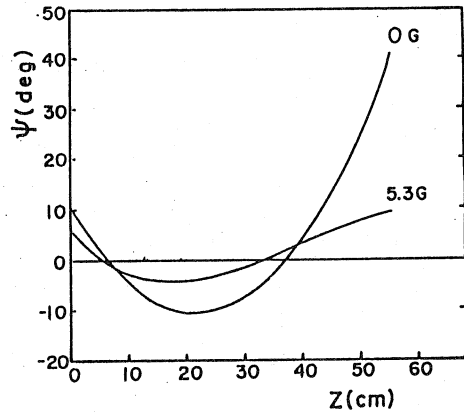

Fig.7. Phase shift of the trapped particle in acceleration.

CONCLUSION

The experimental confirmation of the existence of the $V \times B$ acceleration is shown in a microwave-plasma interaction experiment. A new linear accelerator scheme is explained, which bases on the $V \times B$ scheme by use of a slow wave structure.

ACKNOWLEDGMENTS

The authors are indebted to Dr.R.Sugihara for his valuable discussions and comments. A part of the present work is supported by a Grant-in-Aid for Scientific Research from the Ministry of Education, Science and Culture, Japan.

References

1. T.Tajima and J.M.Dawson, Phys. Rev. Lett. **43**, 267 (1979).
2. C.Clayton et al., Phys. Rev. Lett. **54**, 2343 (1985).
3. F. Martin et al., IEEE Trans. Plasma Sci., PS-15, 167 (1986).
4. R.Sugihara and Y. Midzuno, J.Phys. Soc. Jpn. **47**, 1290 (1979).
5. Y.Nishida, M.Yoshizumi, and R.Sugihara, Proceedings of the 13th Annual Anomalous Absorption Conference, Banff, Alberta, 1983, p.F7; Phys. Letter **105A**, 300 (1984); Phys. Fluids **28**, 1574 (1985).
6. Y.Nishida, N.Y.Sato, and T.Nagasawa, IEEE Transactions on Plasma Science PS-15, 243 (1987).
7. Y.Nishida and R.Sugihara, Laser Interaction and Related Plasma Phenomena vol.7, p.803 (Plenum, New York, 1986).
8. R.Sugihara et al., Phys. Rev. Lett. **52**, 1500 (1984).
9. Y.Nishida and N.Y.Sato, Phys. Rev. Lett. **59**, 653 (1987).