

PRESENT STATUS OF THE OSAKA UNIVERSITY SINGLE BUNCH ELECTRON LINAC

K. Tsumori, S. Takeda, T. Yamamoto, T. Hori, N. Kimura,
J. Ohkuma, T. Sawai, S. Suemine* & M. Kawanishi

Radiation Laboratory
The Institute of Scientific and Industrial Research, Osaka University
*Unicon System

ABSTRACT

A high current injection system for increasing of the single bunch charge was proposed, and it has been installed at the beginning of January, 1984. In the new injector, the multi subharmonic prebunchers are replacing a previous single gap 6th SHPB. After improvement, charge of the single bunch beam has been increased from 14nC to 67nC with energy spread 1 to 2.5% at FWHM, and high charge beam are utilized to the experimenters on the routine works.

INTRODUCTION

The Osaka University Single Bunch Linac was fabricated and installed by System Science and Software (S³) in U.S.A., and the first single bunch beam (39.5 ps, 7.6 nC) was accelerated in July, 1978.¹⁾ Afterward, the single bunch charge was increased from 14 nC to 30.6 nC by deflecting satellite bunches with a 12th single bunch chopper.²⁾ Successively, a new injection system was proposed in order to increase the single bunch charge up to 50 - 60 nC. In this propose, about the two systems that the present 6th subharmonic prebuncher (SHPB) with a new electron gun or a present electron gun with a new multi SHPB,³⁾ were examined. At present, manufacture of the high performance gun (pulse width : 2.5 nS, beam current 40 A) has been found difficult. As a result, new multi SHPB system was adopted. The calculated results and layout of this system are described in other paper.⁴⁾

CONSTRUCTION

The schematic diagram of the new injector is illustrated in Fig. 1. The phase and power controllable rf-amplifiers are provided to drive a 6th and the two 12th SHPBs independently. Also, it is combined with a automatic phase controller to eliminate phase instability at an accelerating gap of

the SHPB due to temperature coefficient of a coaxial feeder or thermal transformation of the SHPB etc.

These SHPB and the drift tubes are confined by the seventeen Helmholtz coils and its axial magnetic field is tapered from 150 Gauss at the entrance to 500 Gauss at the output in order to keep the beam at Brillouin flow condition as the charge density increases due to beam bunching. The beam current monitors attached to the drift tubes were made by the non-magnetic materials to keep field uniformity of the Helmholtz coils. Two additional vacuum stations are installed to ensure adequate pumping of the increased inner surface area of the injection system. The whole view of the new injector is shown in Fig. 2.

The drawing of the re-entrant type cavity for the SHPB which designed refer to the test cavity⁵⁾ is shown in Fig. 3. A coupling loop coil for exciting the cavity, is attached to the atmospheric side using a vacuum tight ceramic dome. By this method, an impedance matching of the cavity could easily adjusted by the rotation of the coupling loop coil as evacuate the cavity. For phase stabilization at the accelerating gap, the phase control circuit requires the low level rf signal at the resonant cavity. Therefore, a small loop coil is also provided. In the cavity, immediately after installation, the multipactoring due to the surface contamination was occurred under the few KW rf driving. Therefore, the surface treatment by the Ar glow discharge cleaning was acted for about 30 minutes.⁶⁾ Consequently, driving power was much increased from 3 KW to 20 KW without difficulty.

The parameters of the 6th and 12th SHPBs cavity is shown in Table 1. At the designing the both cavity, the mechanical dimensions of the all parts were decided equally except the cavity length have relation to the resonant frequency. It is because, so that the simplicity of the machining and material choice.

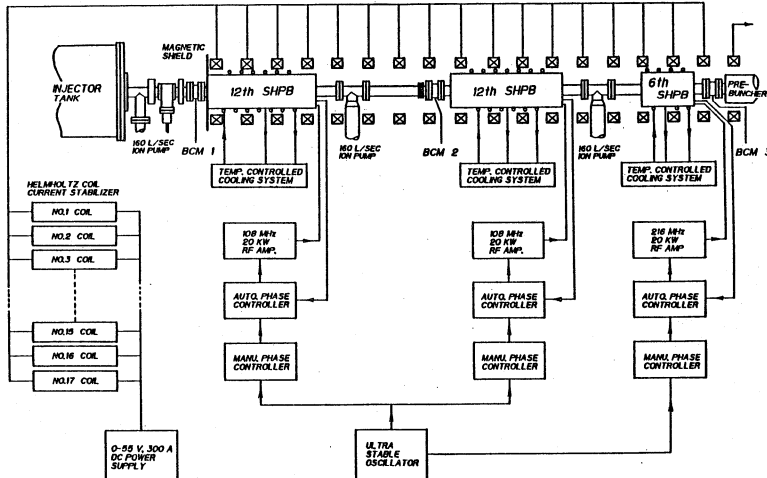

Fig. 1 Schematic diagram of the new injector system.

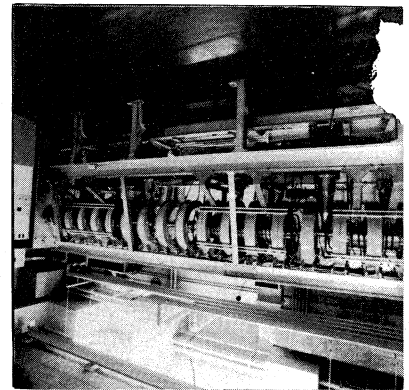

Fig. 2 Whole view of the new injector system. The injector tank is placed at the end of right side.

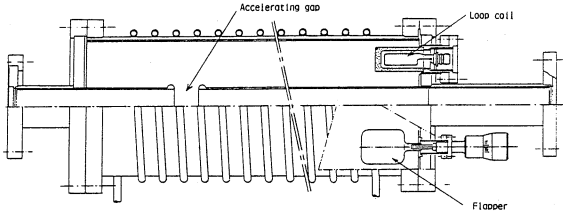

Fig. 3 Re-entrant type rf cavity for the SHPB.

	108 MHz	216 MHz
Cavity Length (mm)	812	394
Cavity Dia. (mm)	190	190
Drift Tube Dia. (mm)	60	60
Gap Length (mm)	34	34
Tuning Range (KHz)	400	32
Frequency Shift (KHz/°C) (25°C - 40°C)	1.83	1.09
Gap Voltage (KV/KW)	~3	-
Q _L	4400	1970
SWR	1.37	1.08
Temp. Control (°C)	0.1	0.1

Table 1 Parameters of the 6th and 12th SHPBs' cavity.

RESULTS AND DISCUSSION

A situation of the bunched beam can be observed using a beam current monitor (BCM) attached to the drift space. Typical wave forms of the both beam injected (broad) and bunched at the 1st 12th SHPB (narrow) are shown in Fig. 4-a. In this figure, the beam charge of the each pulse obtained by the producted of the pulse height and width were both same. It's means that injected beam from the gun was bunched perfectly at the SHPB system. Fig. 4-b shows the situation of the beam bunching with the variations of the rf phase angle at intervals of 30 degrees. This bunching situation have interesting problems as compared with the results of the computer simulation.⁶⁾

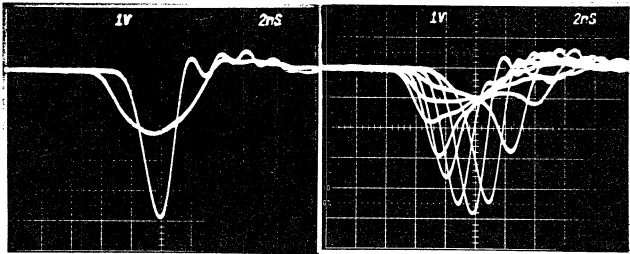

Fig. 4-a

Fig. 4-b

Fig. 4-a Typical wave forms of the injected (broad) and bunched (narrow) beams.

Fig. 4-b Situation of the beam bunching with variations of the rf phase angle.

The accelerating wave guides including the drift tubes are confined by the thirty six Helmholtz coils. Especially, seventeen coils for the injection system are individually magnetized by reason of keeping the beam at Brillouin flow condition as the charge density increase due to beam bunching. Fig. 5-a shows, the typical Z-axis magnetic field distribution by the Helmholtz coils at the single bunch mode operation. If the accelerating condition is normal, the field strength ought to gradually increased by reason of the above mentioned, but in this results, it was observed as hollow between the 6th SHPB and the prebuncher. In this problem is explained as follows : When intense bunched beam passing the rf cavity or other hollow part, the wake field are generated there, and its potential have an effect on the bunched electrons. Consequently, for waken the bunch-cavity intaraction, beam current density should be reduced. It can be achieved by reducing the magnetic fields in order to enlarge the beam diameter.

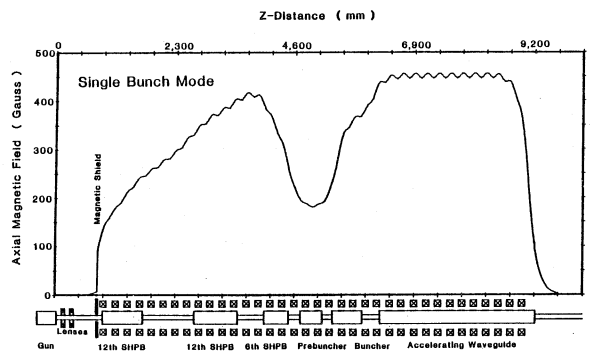

Fig. 5-a Typical Z axis magnetic field distribution at the single bunch mode.

On the other hand, similar field distribution on the transient mode operation is shown in Fig. 5-b. In this mode, the rf exiting to the all SHPBs has been stopped. Therefore, current density of the injected beam doesn't vary while passing the injection system. It is because, no need for the magnetic field gradient as in Fig. 5-b.

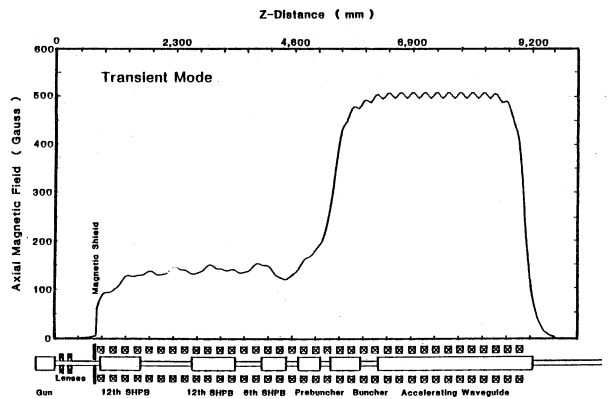

Fig. 5-b Typical Z axis magnetic field distribution at the transient mode.

REFERENCES

- 1) K. Tsumori, N. Kimura, T. Yamamoto, T. Hori, S. Takeda, J. Ohkuma and T. Sawai: Proc. 5th Meeting on Linear Accelerator in Japan, 23 (1980).
- 2) K. Tsumori, N. Kimura, T. Yamamoto, T. Hori, S. Takeda, J. Ohkuma, T. Sawai and M. Kawanishi: Proc. 4th Symposium on Accelerator Science and Technology, 43 (IPCR, 1982).
- 3) S. Takeda, K. Tsumori, N. Kimura, T. Yamamoto, J. Ohkuma, T. Sawai, T. Hori and M. Kawanishi: Proc. 7th Meeting on Linear Accelerators in Japan, 115 (KEK, 1982).
- 4) S. Takeda, K. Tsumori, N. Kimura, T. Yamamoto, J. Ohkuma, T. Sawai, T. Hori and M. Kawanishi: Proc. 4th Symposium on Accelerator Science and Technology, 275 (IPCR, 1982).
- 5) K. Tsumori, T. Yamamoto, T. Hori, N. Kimura, S. Takeda, J. Ohkuma, T. Sawai, and M. Kawanishi: Proc. 8th Meeting on Linear Accelerators in Japan, 23 (INS, 1983).
- 6) H. Kitamura, M. Kobayashi, Y. Takiyama and K. Huke: Proc. 4th Symposium on Accelerator Science and Technology, 219 (IPCR, 1982).
- 7) S. Takeda, N. Kimura, K. Tsumori, M. Kawanishi and T. Shintake: presented at this conference.

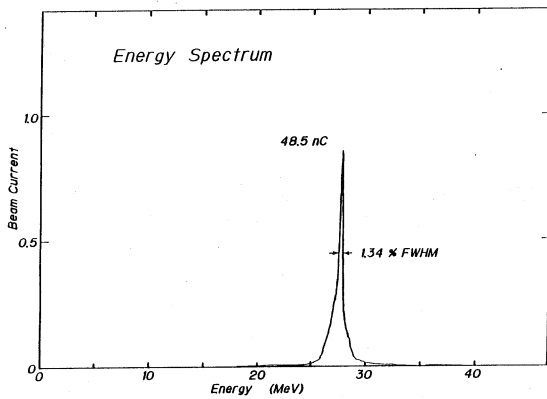

Fig. 6 Typical energy spectra in the single bunch beam at 48.5 nC.

The typical energy spectra in the single bunch mode at 48.5 nC is shown in Fig. 6. The energy spread of this mode, in the range between 0 nC and 16 nC is estimated to be 1 %, and also between 40 nC and 67 nC is increased up to 2.5 %. The most minimized energy spread is obtained at 33 nC, and it is estimated to be 0.7 %. The energy spread depends on the phase angle by which the bunch front leads the crest of the accelerating wave produced by the wake field. The details of these problems are reported in this conference.⁷⁾

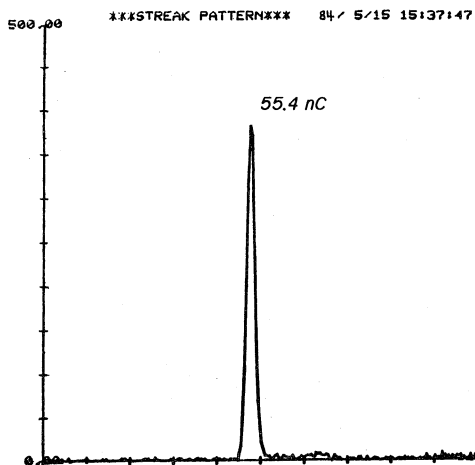

Fig. 7 Pulse width of the single bunch beam at 55.4 nC.

In order to determine the single bunch pulse width a cell filled with Xe gas is measured by an ultrafast streak camera (Hamamatsu C979 and C1098). Typical pulse width at 55.4 nC is shown in Fig. 7. The pulse width was found to be 35 pS at FWHM from 7 nC to 35 nC, and at the higher charges the pulse width became broader slightly.

In this linac, maximum charge of the single bunch beam can be generated to 67 nC, and it has been limited by the maximum injection current at 30 A, 4.5 nS FWHM using the ARCO Model 12 gun. In order to generate the more high charge beam, development of the high performance gun (45 A, 4.5 nS, rise time 1 nS) with an avalanche grid pulser has just started. When it has succeeded, beam will get to 100 nC or more.