

SYNCHROTRON RADIATION RESEARCH AT THE PHOTON FACTORY

T. Sasaki and K. Kohra

Photon Factory,
National Laboratory for High Energy Physics

The Photon Factory is a synchrotron radiation research center affiliated to the National Laboratory for High Energy Physics, with a 2.5 GeV electron linear accelerator as the injector and a 2.5 GeV electron storage ring as the dedicated synchrotron radiation source.

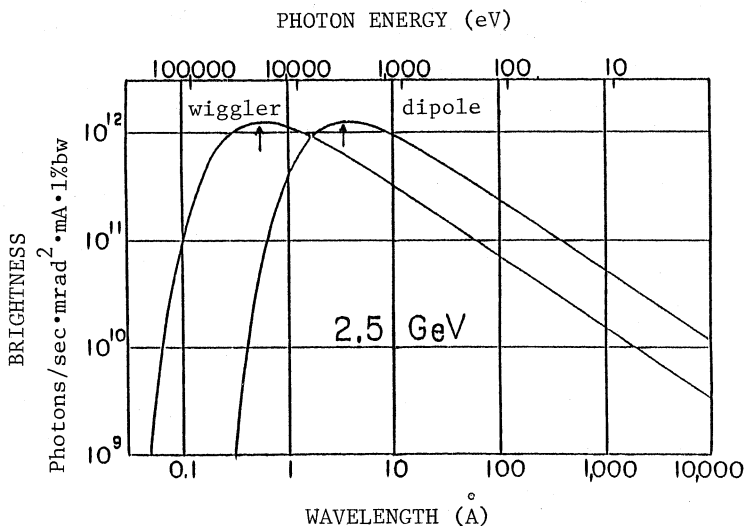

Fig.1

Spectral brightness of synchrotron radiation from the light source of Photon Factory at 2.5 GeV. Arrows indicate the characteristics wavelengths, λ_c .

The useful spectral range and brightness of the source is given in Fig. 1, which shows two different spectra, one from the dipoles as the regular lattice elements and another from a vertical wiggler as an insertion. The characteristic wavelengths are 3.1 Å from a dipole, and 0.5 Å from a wiggler, respectively, as indicated in the figure. The light source provides accordingly useful radiations extending from ultraviolet through fairly hard X-rays, down to 0.1 Å. The construction started in 1978 and the light source became operational since March 1982. 13 beam lines will be ready for use by the end of the fiscal year 1984. As of June 1982, when the regular operation of the light source for radiation users started, four beam lines were completed, and initial efforts of testing instruments and performing a variety of experiments have yielded a number of successful as well promising results.

Figure 2 shows a schematic arrangement of the experimental hall and beam lines. BL's 10, 11, 12, 15 are currently operated lines, and BL's 1, 2, 4, 14, 21 are under construction. BL-10, 15, 4 are X-ray beam lines to be used for X-ray crystallography by diffraction, X-ray absorption or fluorescence spectroscopy or EXAFS, solid state studies by means of diffuse scattering, trace analysis by fluorescence, material studies by topography, molecular biology and physiology by small angle scattering, X-ray diffraction studies of gases, liquid and melt substances, matters under very high pressures and high temperatures, or under low temperatures, or with extremely high precision, various inelastic X-ray scattering studies and so on. Figure 3, for instance, is a

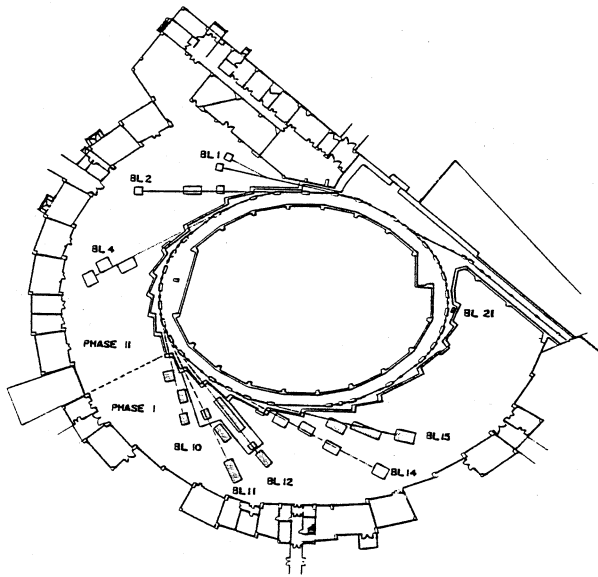

Fig.2 Experimental hall and beam lines of Photon Factory.

schematic drawing of the BL-10 with three branch beam lines and stations 10A for X-ray crystallography for minerals, 10B for EXAFS, and 10C for focused monochromatic X-rays. As an example, Ge K absorption spectra of crystal and amorphous GeTe obtained at 10B are given in Fig. 4. BL-14 under construction is a beam line for the hard X-rays emitted from a vertical wiggler with a 6 Tesla superconducting magnet. The wiggler has recently been incorporated into the storage ring orbit, and will shortly be operated.

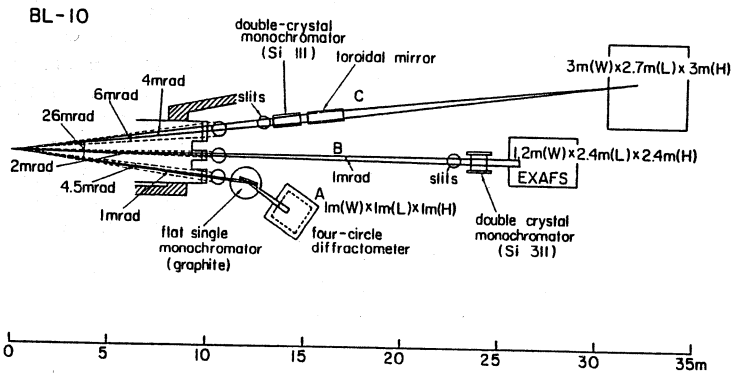

Fig.3

BL-10 an X-ray beam line for crystallography, spectroscopy, and experiments using monochromatic, focused beam of X-rays.

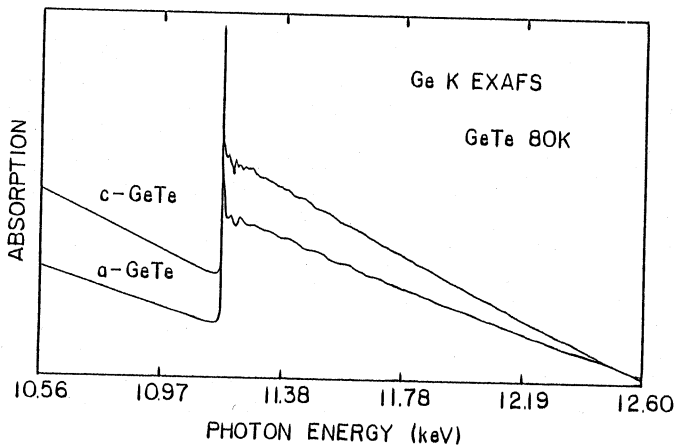

Fig.4

K-absorption spectra of germanium in single-crystal and amorphous GeTe. Note the difference above the threshold. (10B)

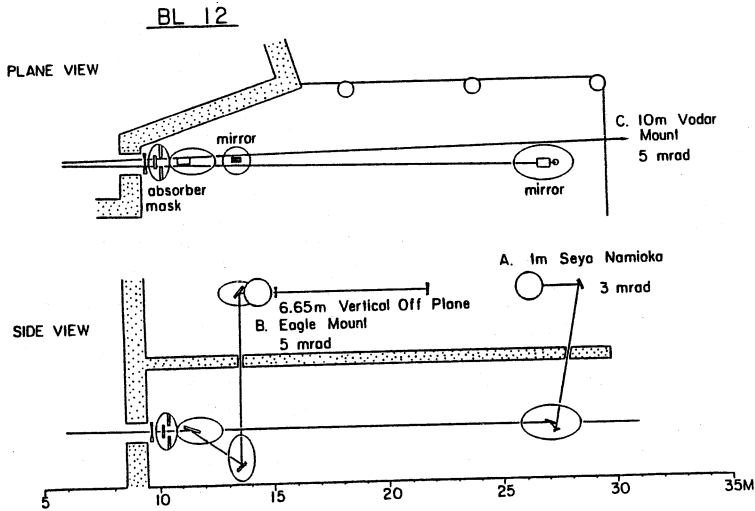

Fig.5

BL-12, a beam line for extreme ultra-violet and soft X-ray spectroscopy. Two monochromators at 12B and 12C are challenges for the highest resolution.

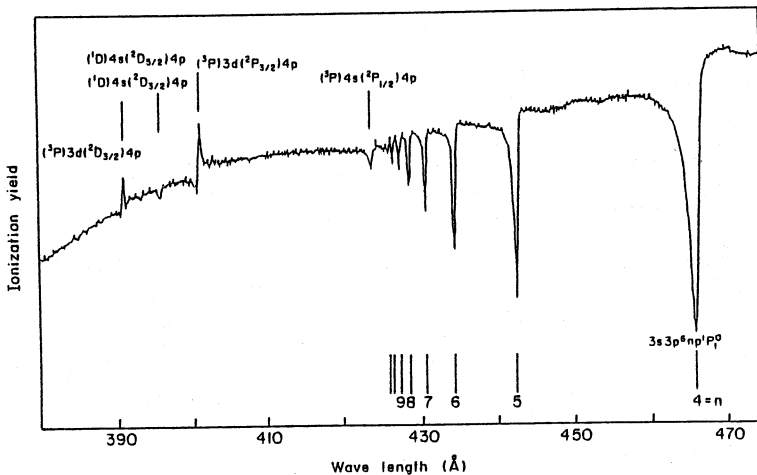

Fig.6

Ionization spectrum of argon determined by an ion chamber. 3s Rydberg series overlapped with a 3p continuum giving a window type autoionizing spectrum. (12A)

BL's 11, 12, 1 and 2 will be dedicated to fundamental and applied spectroscopy in the extreme ultraviolet through the soft X-ray region.

Figure 5 gives an example of a beam line BL-12 for vacuum ultraviolet spectroscopy. This line is also divided into three branches, two of which are deflected upwards by SiC mirrors and XUV monochromators are installed on the mezzanine, and a high resolution soft X-ray monochromator uses the rest of the beam. Figure 6 shows a spectrum of photoionization of argon including the region of autoionization obtained at the station 12A. BL-1 will be constructed by Nippon Telephone and Telegram Corporation as a joint endeavor of NTT and KEK for establishing a beam line with stations for soft X-ray lithography and relevant research on solid state devices. BL-2 will be used for photoionization studies, lithography and other applications of soft X-rays with undulator radiation (UR) from a 59 period permanent-magnet undulator under construction. Figure 7 shows its spectrum expected for given parameters. As it is impossible to describe every aspect of activity at the Photon Factory within a limited space, only one more result which would envisage some aspect of synchrotron radiation research will be given in Fig. 8.

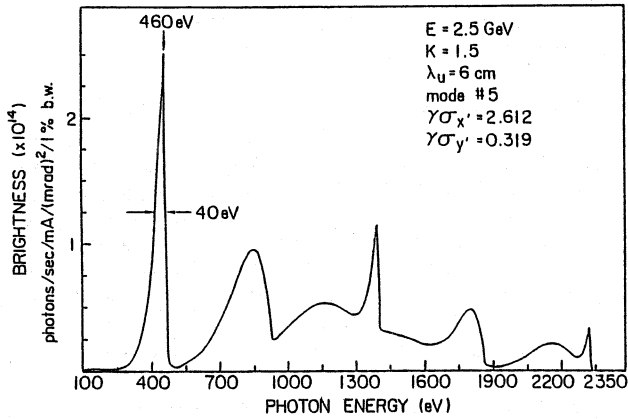

Fig.7

Theoretical spectral brightness of undulator radiation from a permanent magnet undulator with 59 periods under the current mode of operation. (BL-2)

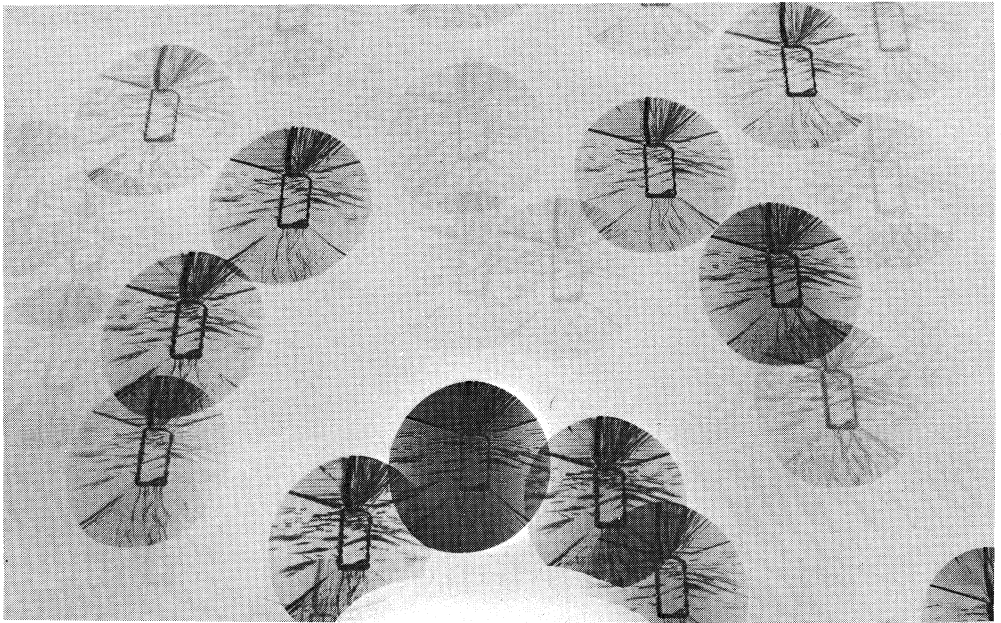

Fig.8 X-ray diffraction topograph of a synthesized crystal of quartz. The seed crystal is distinguished by a rectangular shadow. (15B)

The materials and the experimental results presented here have been worked out by many collaborators including in-house staff and users. The authors acknowledge their courtesies in making them available prior to publication.