

加速器ベース・ホウ素中性子捕捉療法

Accelerator-based Boron Neutron Capture Therapy

第12回日本加速器学会年会(2015年8月7日)

Masakazu Yoshioka (University of Tsukuba /KEK)

Hiroaki Kumada (University of Tsukuba)

Many thanks to collaborators and industries;

- **Special thanks to J-PARC group and Ibaraki Prefecture!!!**
- **KEK:** Hiroshi Matsumoto, Fujio Naito, Noriyuki Matsumoto, Yoshiaki Murakami, Hitoshi Kobayashi, Toshikazu Kurihara
- **University of Tsukuba:** Akira Matsumura, Hiroaki Kumada, Susumu Tanaka, Kohji Niita
- **JAEA:** Takemi Nakamura, Kazuo Hasegawa, Yasuo Kondo
- **Cosylab:** Takashi Nakamoto, Tilen Zagar
- **Nihon Advanced Technology:** Toshiyuki Ohba, Nobuaki Nagura
- **ATOX:** Toshikazu Ohuchi, Hisashi Sakurayama
- **Mitsubishi Heavy Industries:** Tomei Sugano, Tomohiro Tsuiki
- **Many other industries:** Taiyo Valve, Toshiba EDT, Nichicon, DAWONSYS (Korea), Nihon Koshuha, TOYAMA, NEC/TOKIN, Kanto Giken, オオツカ and many others,,,,,,,,

①BNCTとは

②3つのアプローチ(京大、いばらき、がんセンター)

③中性子スペクトラム、必要な中性子と有害成分

④コミッショニング計画

⑤OIST(沖縄科学技術大学院大学)計画

⑥サマリー

Principle of Boron Neutron Capture Therapy (BNCT)

Administer boron-containing drug

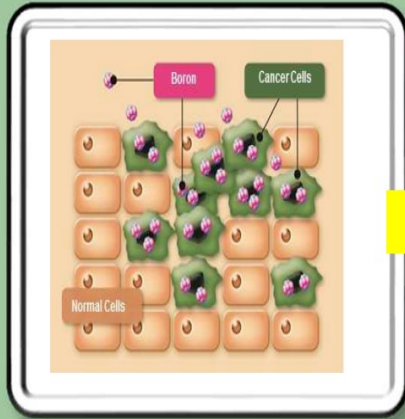

A boron-containing drug that selectively accumulates in cancer cells is used.

Neutron irradiation

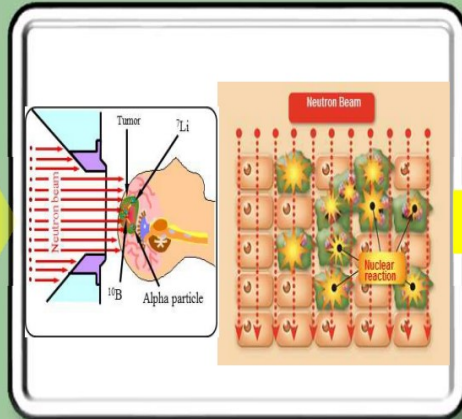

The affected site is irradiated with an energy-adjusted neutron beam.

Neutron react with boron:



Emitted alpha particles and lithium particles destroy cancer cells

Cancer cells are destroyed:

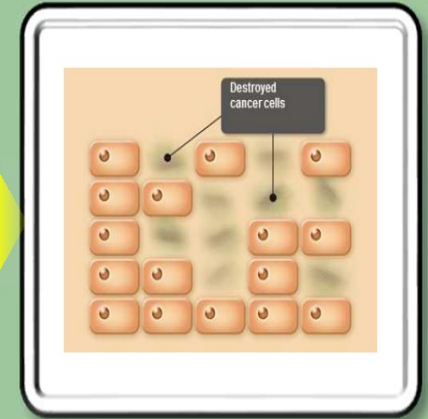

These particles only travel a distance of one cell width (about $10\mu\text{m}$), allowing for cell-level treatment.

➤ Pinpoint treatment at cell level

Alpha beam and lithium particles, with energy three times higher than regular X-ray radiation, selectively destroy the DNA helixes of cancer cells.

➤ New treatment of refractory cancer

Including invasive cancer, multiple cancer, recurrent cancer, radiation-resistant cancer, cancer patient not indicated for surgery or radiation therapy, etc

➤ Causes minimal stress and provides high quality of life

Treatment is completed in only one session of 30-minute irradiation without incision. Indication for medication can be determined with PET in advance.

Position of BNCT in cancer therapy

cancer

A large, empty, horizontally-oriented oval shape with a thin black outline, centered on the page. The word "cancer" is written vertically inside the oval.

Position of BNCT in cancer therapy

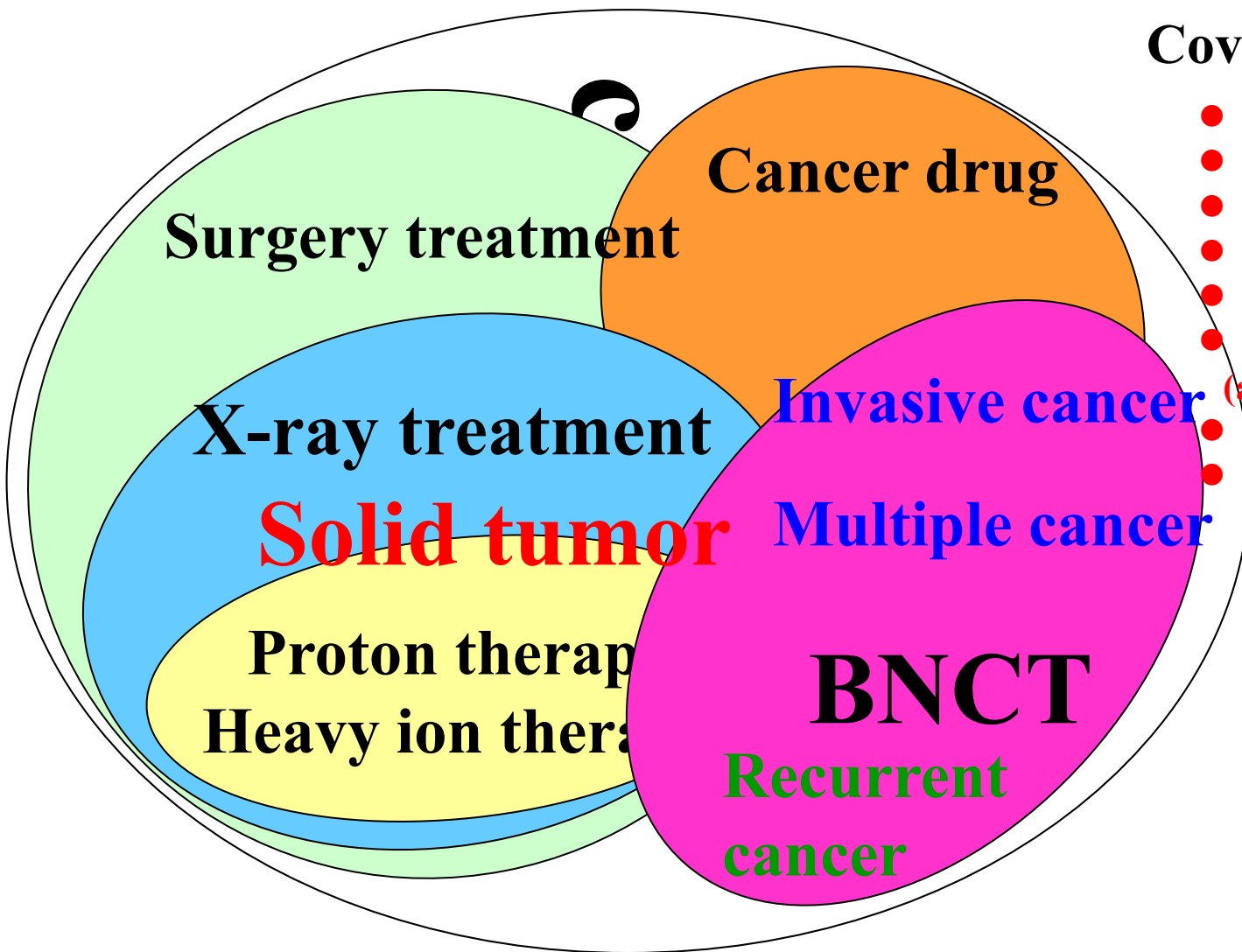

Coverage of BNCT

- Brain malignancy
- Head neck cancer
- Malignant melanoma
- Lung cancer
- Multiple liver cancer
- Mesothelial cancer
- (asbestos exposure victim)
- Recurrent breast cancer
- Various recurrent cancer

Neutron Source: Replace the Research Reactor with Accelerator
→ Accelerate Drug development

①BNCTとは

②3つのアプローチ(京大、いばらき、がんセンター)

③中性子スペクトラム、必要な中性子と有害成分

④コミッショニング計画

⑤OIST(沖縄科学技術大学院大学)計画

⑥サマリー

Basic configuration of proton linac for i-BNCT

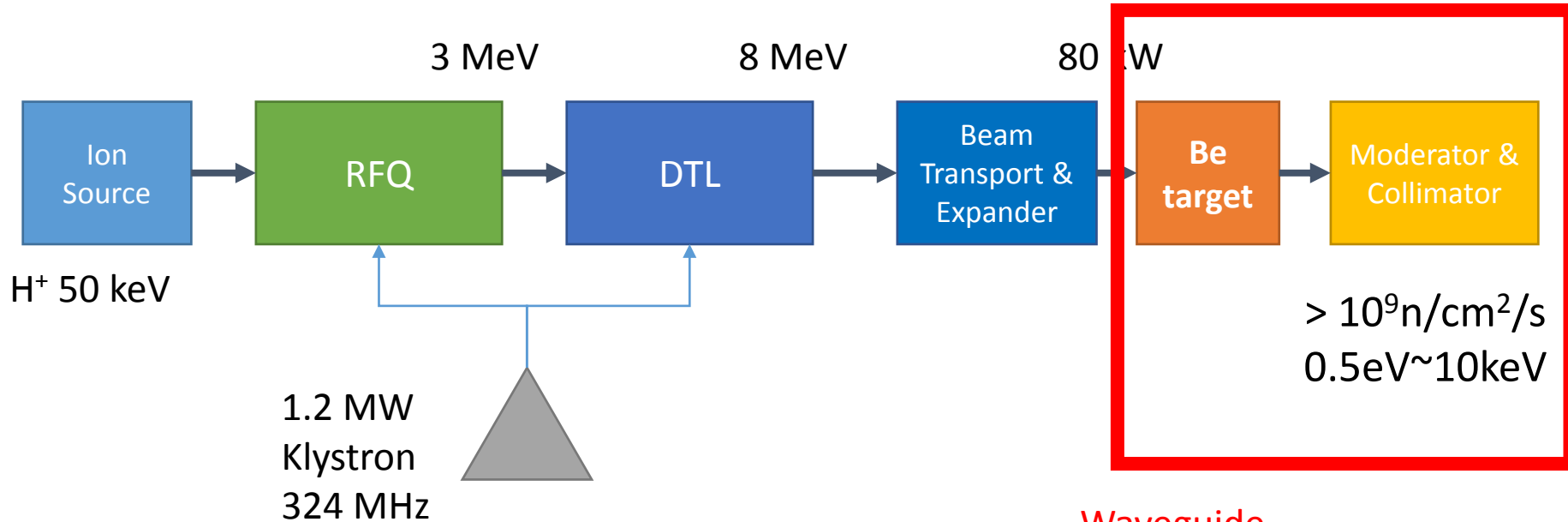

Peak current	Max. 50 mA
Pulse width	Max. 1 ms
Pulse repetition	Max. 200 pps
Duty	20%
Beam power	80 kW

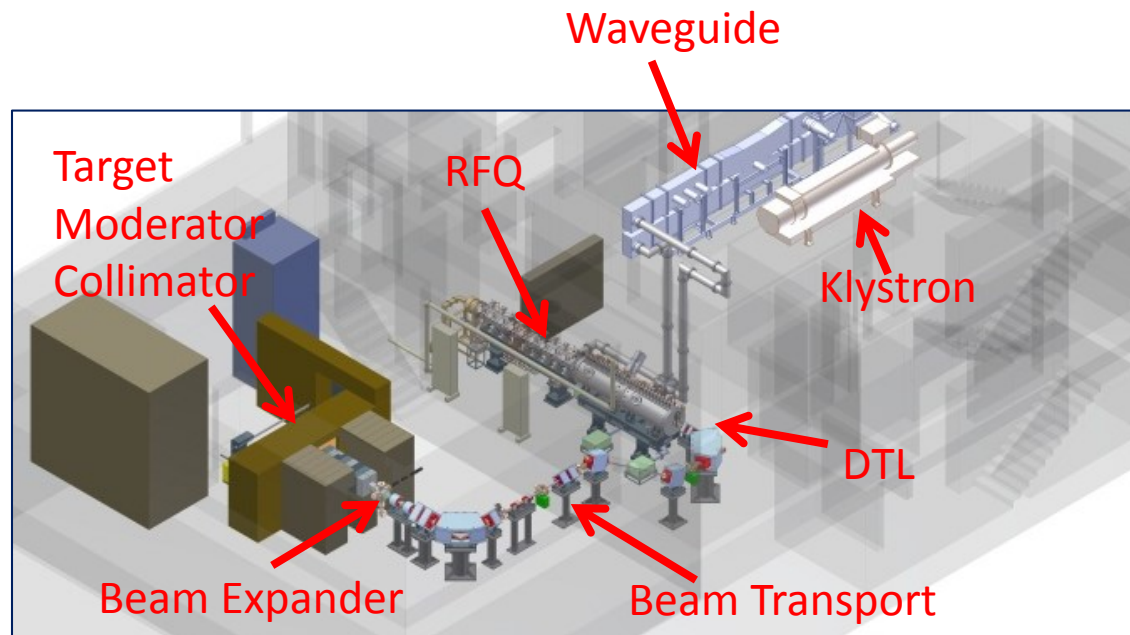

日本では3つのグループ

- ◆ いばらき 8MeV Linac、ベリリウム標的)
 - コミッショニング中
- ◆ 京都大学(30MeVサイクロトロン、同上)
 - 患者に対して治験実施中
- ◆ がんセンター(2.5MeV Linac、リチウム標的)
 - コミッショニング中??

①BNCTとは

②3つのアプローチ(京大、いばらき、がんセンター)

③中性子スペクトラム、必要な中性子と有害成分

④コミッショニング計画

⑤OIST(沖縄科学技術大学院大学)計画

⑥サマリー



Design using MCNPX

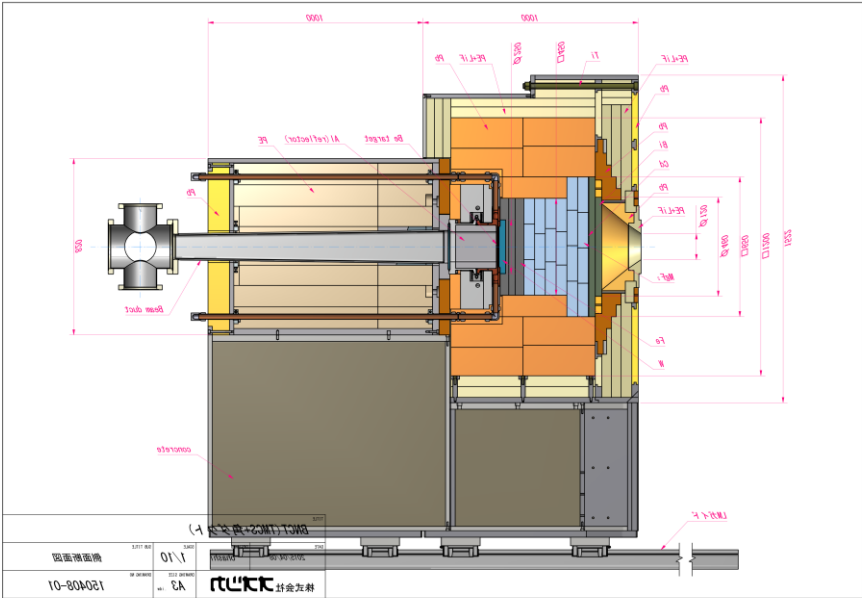

Neutron energy spectrum at the patient position: 0.5 eV ~ 10 keV

Neutron energy spectrum at the Be target for various production angles
Primary proton energy is 8 MeV

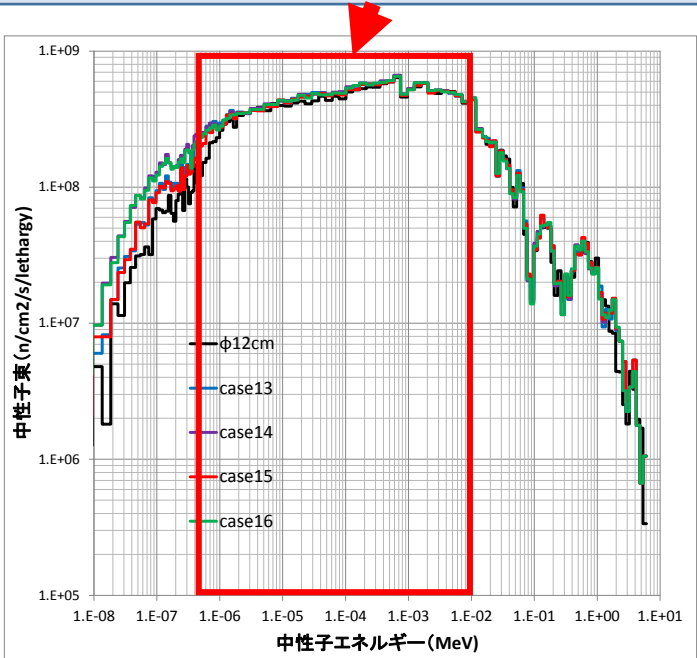
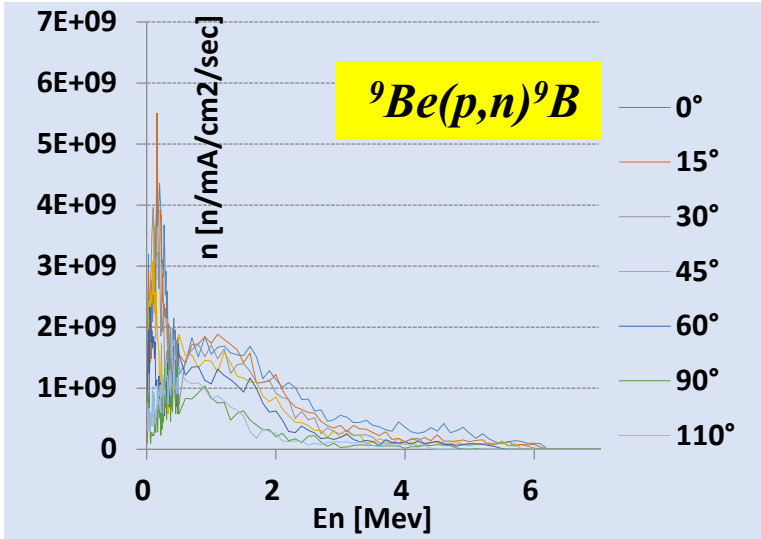

中性子フラックス と 有害成分

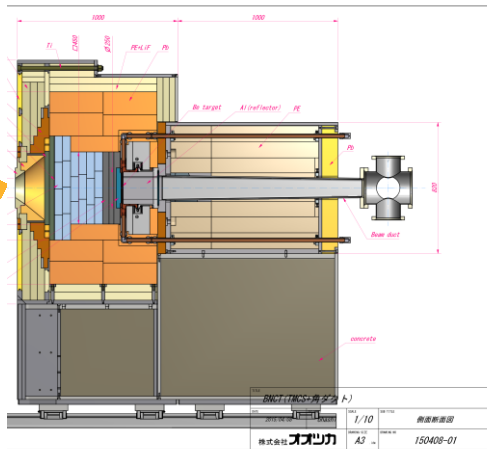

0.5eV~10keV Neutron flux
 $> 4.3 \cdot 10^9 \text{ n/cm}^2/\text{s}$

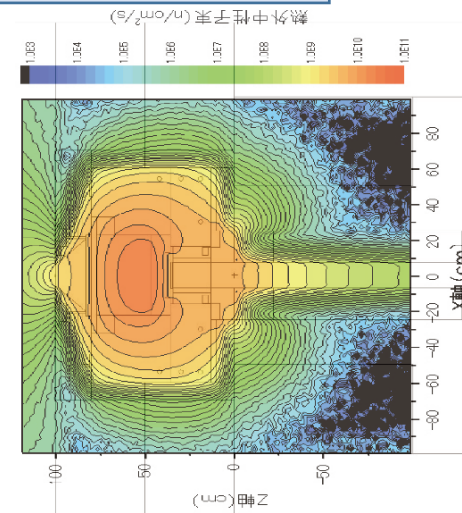
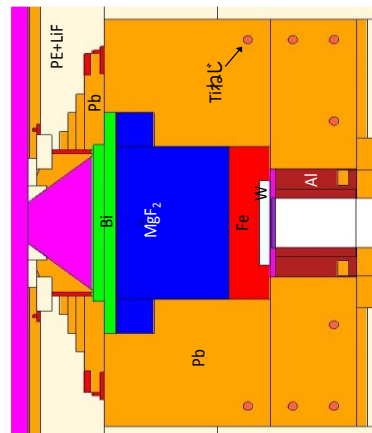

Neutron $< 0.5 \text{ eV}$
 1.8×10^8

γ -ray
 0.74 Gy/h

Neutron $> 10 \text{ keV}$
 4.7×10^8

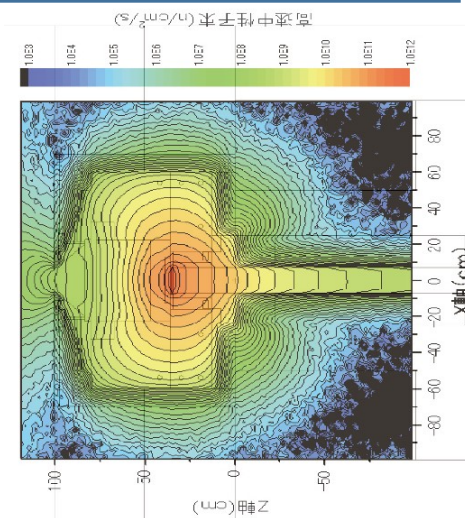
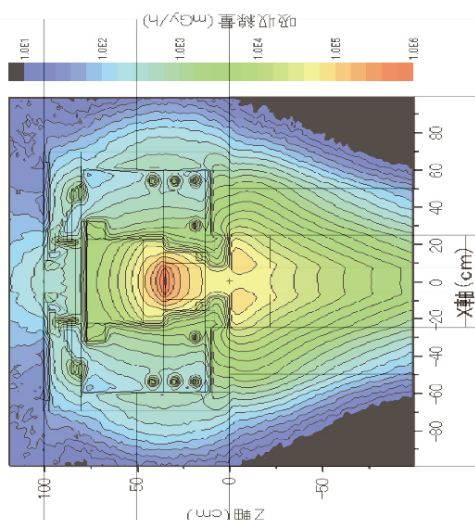
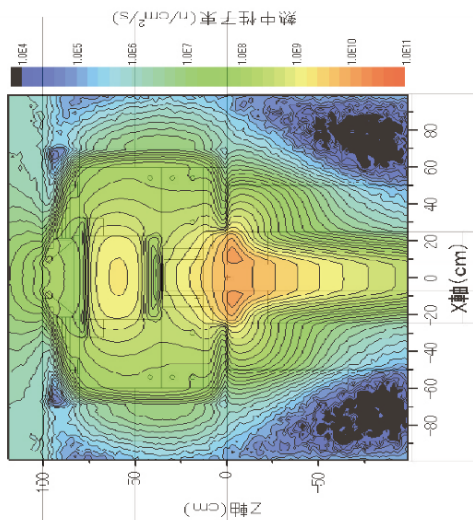

As low as possible

年に1回程度のターゲット交換作業時の残留放射能による空間線量率 PHITS + DCAIN-SP 接続計算による評価

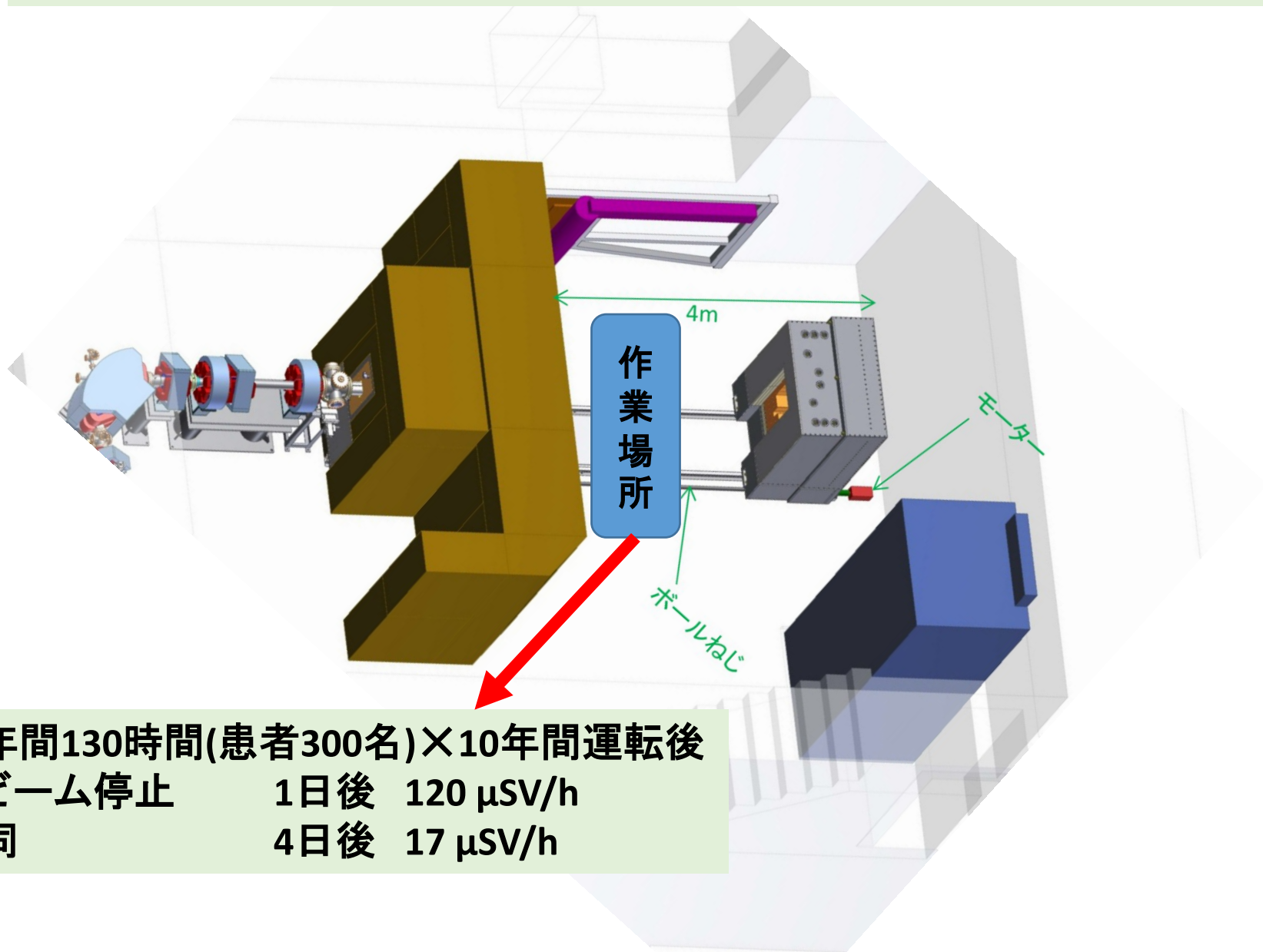

年間130時間(患者300名)×10年間運転後
ビーム停止 1日後 120 μ SV/h
同 4日後 17 μ SV/h

①BNCTとは

②3つのアプローチ(京大、いばらき、がんセンター)

③中性子スペクトラム、必要な中性子と有害成分

④コミッショニング計画

⑤OIST(沖縄科学技術大学院大学)計画

⑥サマリー

Installation of RF system and beam transport by 2014

1.2 MW Klystron



Modulator
1 ms, -90kV,
33A, 200 Hz



Beam transport & expander



RF Conditioning

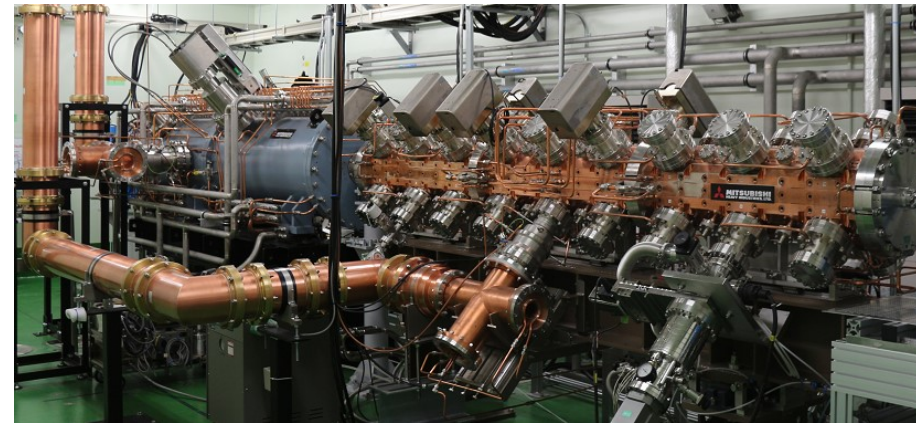
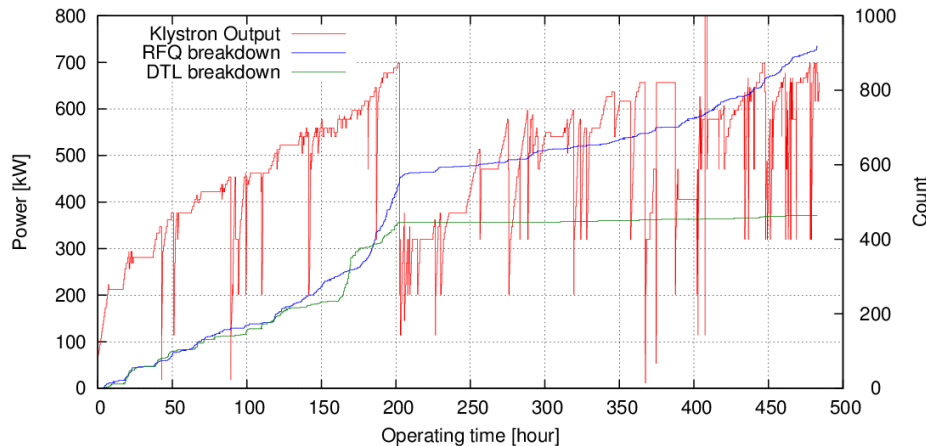

First beam commissioning was completed in December 2014

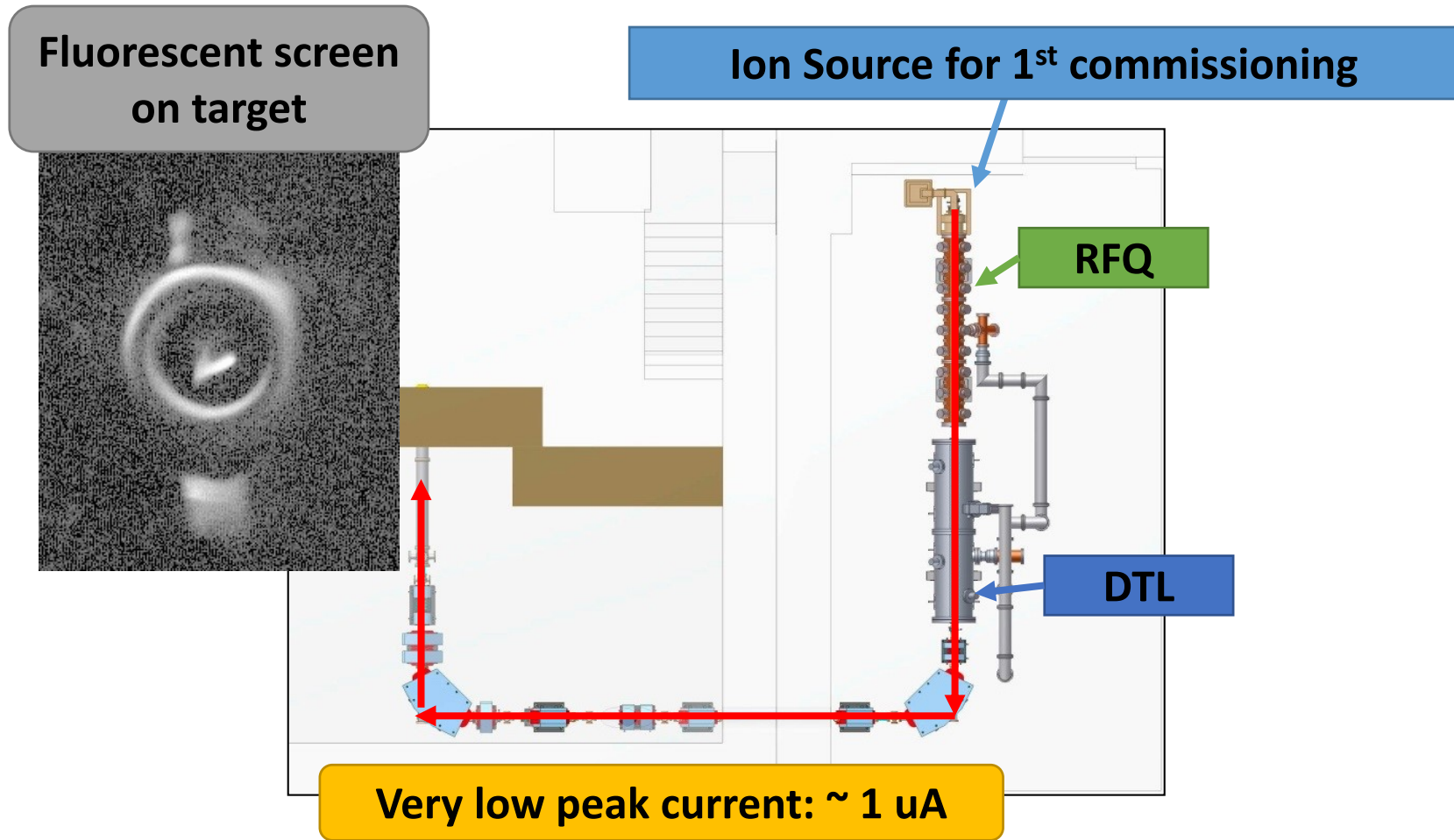



ECR ion source for Ibaraki-BNCT

2 solenoids for ECR condition (874 gauss)

Ridge waveguide

3 electrodes

DC break and RF window

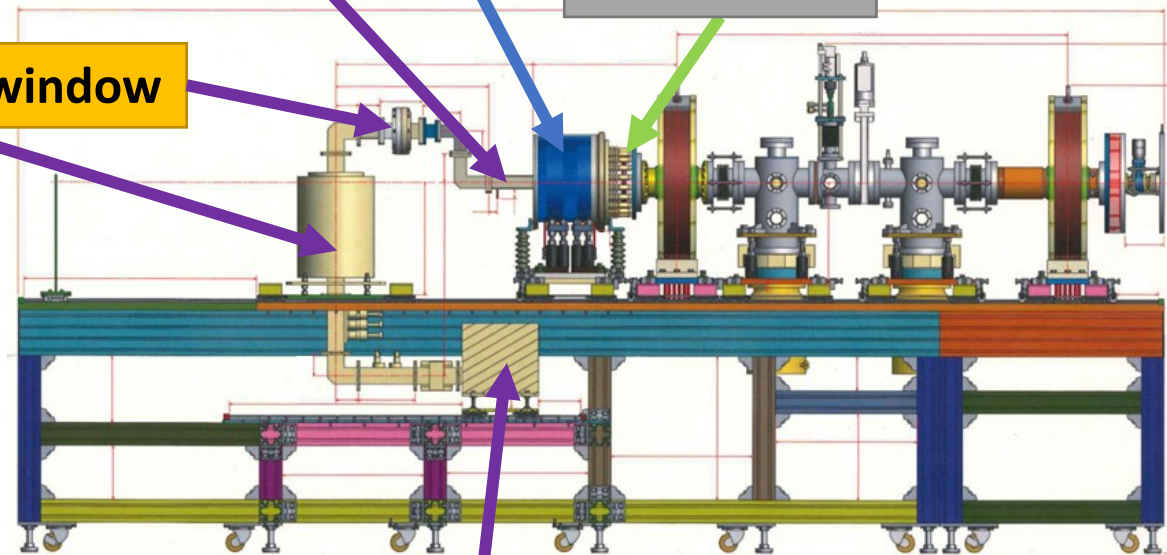

Magnetron

LEBT

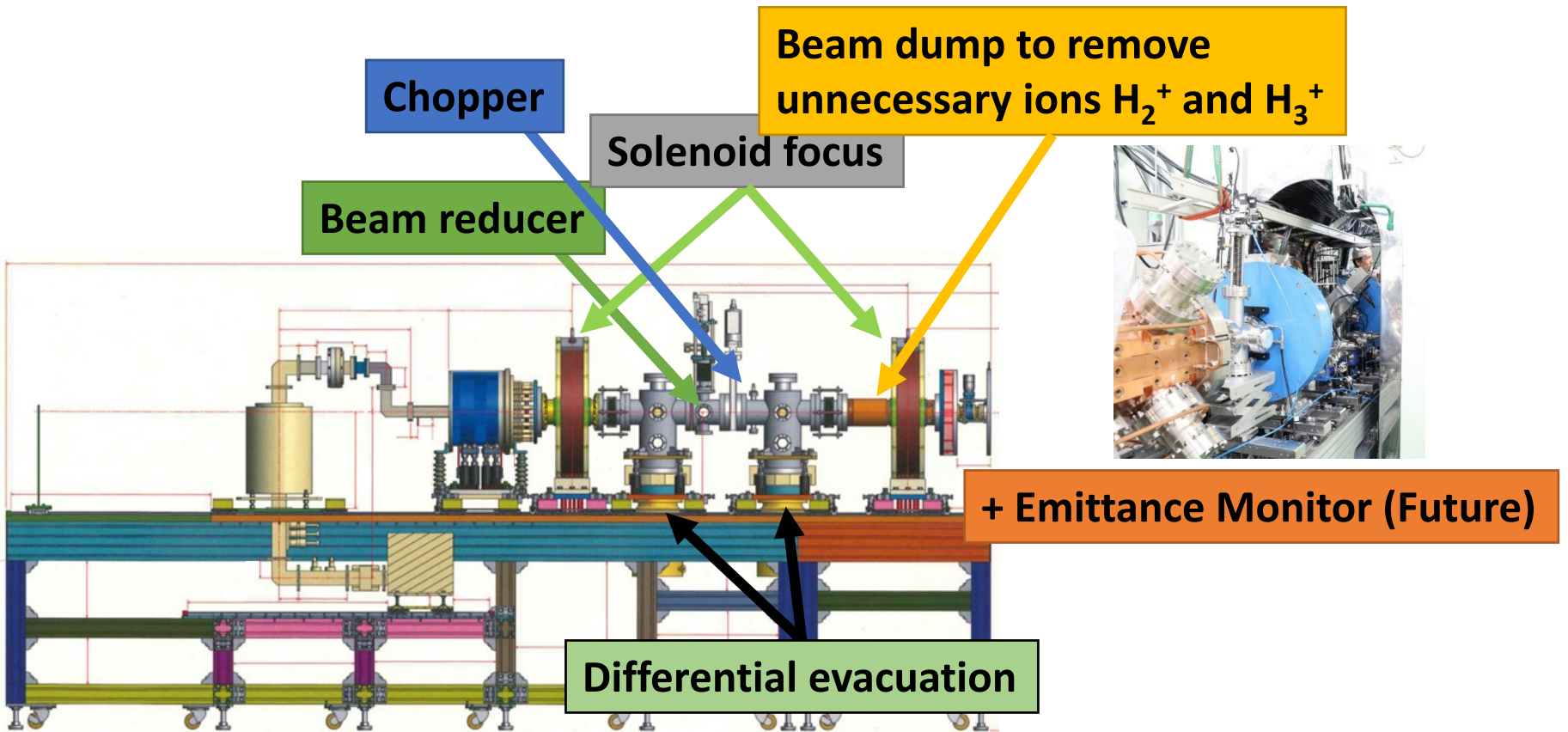

照射室完成 大塚製作所、関東技研に感謝

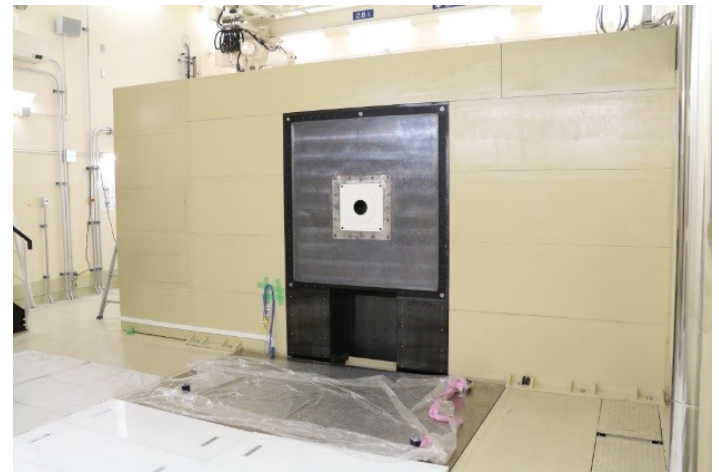

現在：中性子コミッションング中 → 今年度内動物実験、細胞実験
来年度：医学研究開始

14 Beam Diagnostics (for high current)

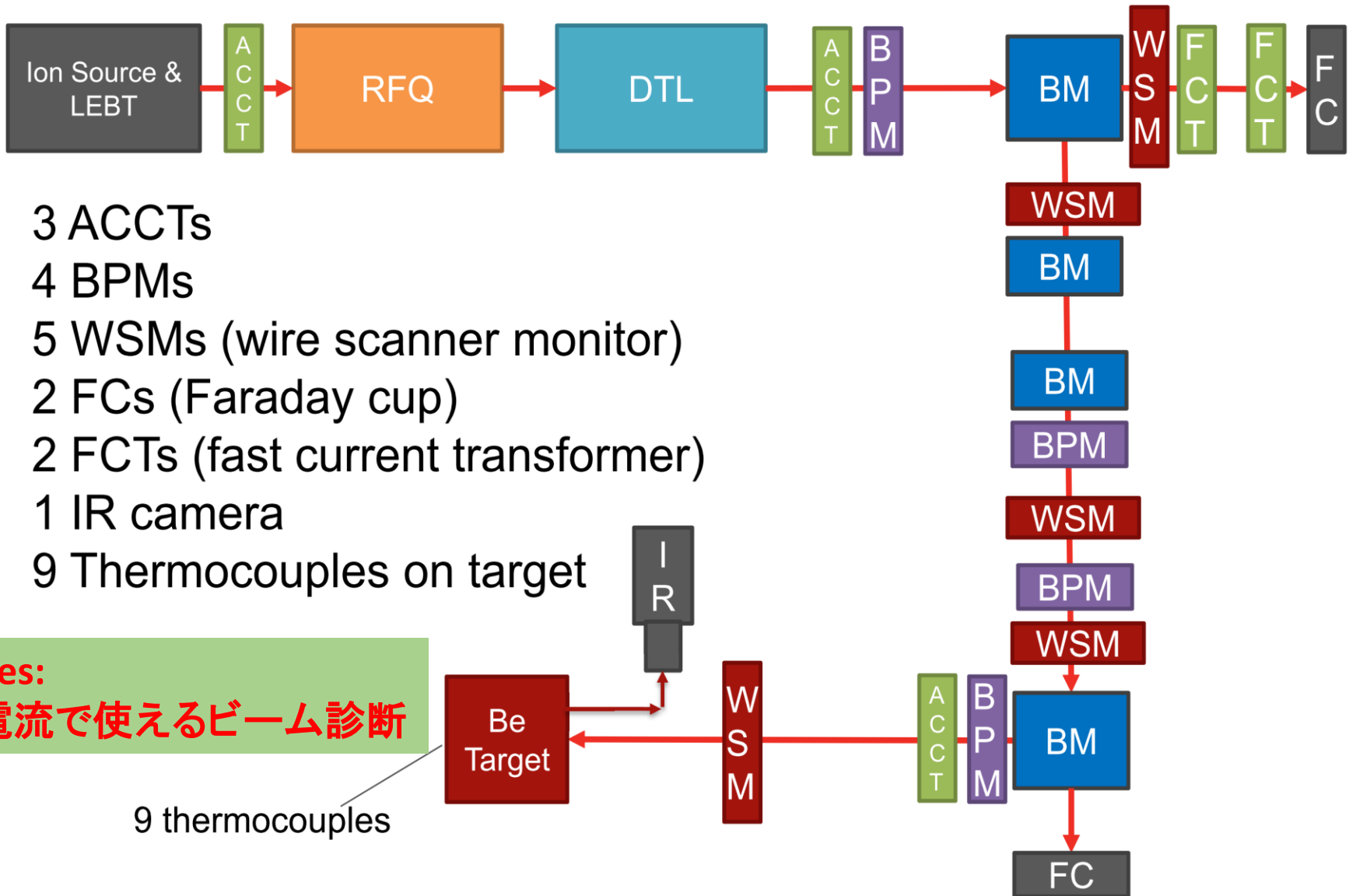

- 3 ACCTs
- 4 BPMs
- 5 WSMs (wire scanner monitor)
- 2 FCs (Faraday cup)
- 2 FCTs (fast current transformer)
- 1 IR camera
- 9 Thermocouples on target

Issues:
大電流で使えるビーム診断

9 thermocouples

①BNCTとは

②3つのアプローチ(京大、いばらき、がんセンター)

③中性子スペクトラム、必要な中性子と有害成分

④コミッショニング計画

⑤OIST(沖縄科学技術大学院大学)計画

⑥サマリー

OIST-BNCT possible configuration: 3MeV (RFQ) + 5 MeV (DTL) + 2 MBK case design

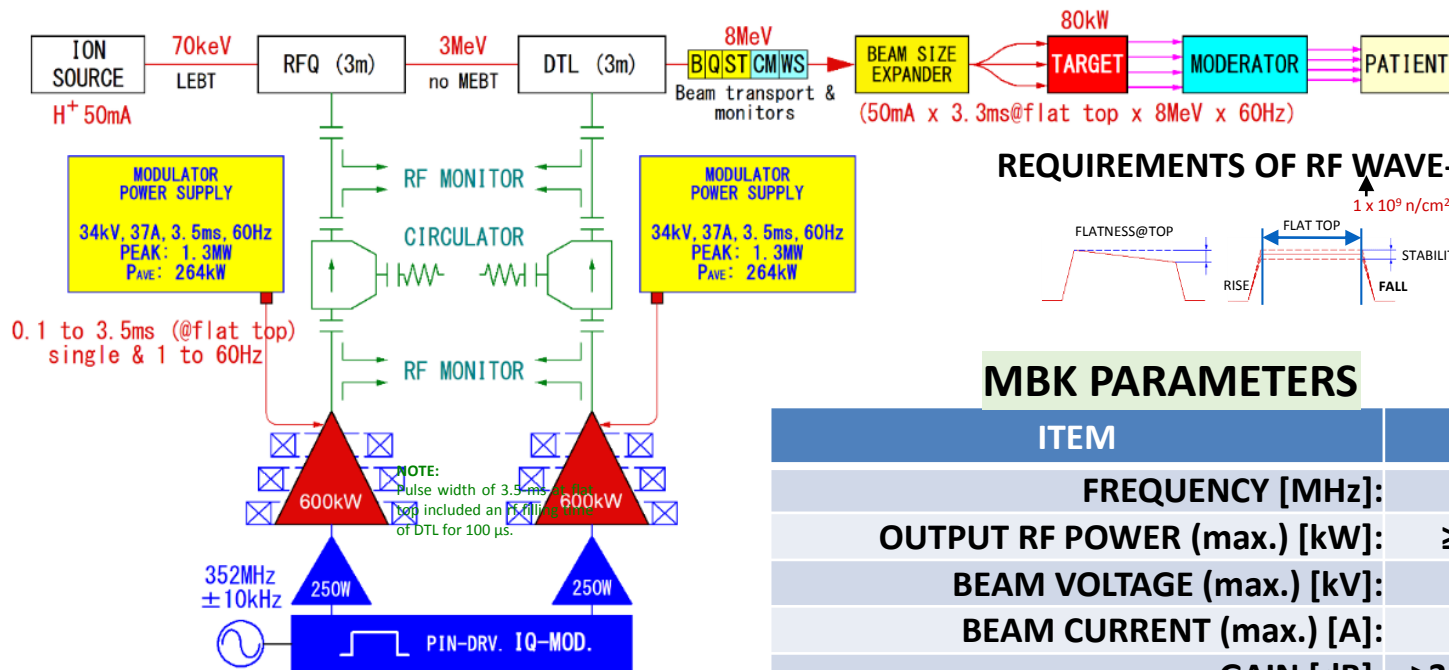

REQUIREMENTS OF RF WAVE-FORMS



MBK PARAMETERS

ITEM	VALUE
FREQUENCY [MHz]:	325 ± 0.1
OUTPUT RF POWER (max.) [kW]:	≥600 (≤625)
BEAM VOLTAGE (max.) [kV]:	31 (≤34)
BEAM CURRENT (max.) [A]:	33 (≤37)
GAIN [dB]:	≥33.8 @600 kW
EFFICIENCY AT SATURATION [%]:	≥55

BEAM PARAMETERS

ITEM	VALUE
BEAM ENERGY [MeV]:	8 (3 +5)
BEAM ENERGY JITTER [%]:	<±0.5
PEAK BEAM CURRENT [mA]:	50
AVERAGE BEAM CURRENT [mA]:	10.5
BEAM POWER [kW]:	84
PULSE WIDTH@FLAT TOP [ms]:	0.1 to 3.3
MAX. REP. RATE [Hz]:	60

MODULATOR POWER SUPPLY SPECIFICATION (for each)

ITEM	VALUE
P _{PEAK} (max.) [MW]:	1.0 (1.3)
P _{AVE} (max.) [kW]:	215 (264)
VOLTAGE (max.) [kV]:	31 (34)
CURRENT (max.) [A]:	33 (37)
PULSE WIDTH@FLAT TOP [ms]:	0.1 to 3.5
RISE & FALL TIME (0 to 100%) [ms]:	<0.1
FLATNESS @TOP (RMS):	<5 × 10 ⁻⁴
STABILITY @TOP (RMS):	<5 × 10 ⁻⁴
REP. RATE [Hz]:	single & 1 to 60

MBK: multi beam Klystron
One of the key technologies

TOSHIBA Multi-Beam Klystron (MBK) E3736 for ILC & XFEL(SRF)

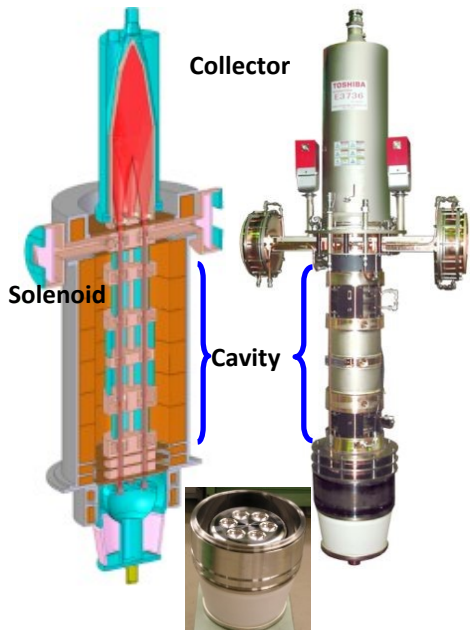

Electron gun : 6 beams

i-BNCT Klystron system E37619
Single beam, 1.2 MW, -90kV, 33A

1.2 MW Klystron



Modulator



OIST-BNCT Klystron system: 6 beams, 600 kW, -31kV, 33A

Advantage of MBK by comparing with SBK:

- higher AC to RF power conv. eff. (61/54 %)
- lower modulator power supply voltage (31/91 kV)
 ➔ compact and reliable modulator power supply
- Longer cathode life due to lower cathode loading

①BNCTとは

②3つのアプローチ(京大、いばらき、がんセンター)

③中性子スペクトラム、必要な中性子と有害成分

④コミッショニング計画

⑤OIST(沖縄科学技術大学院大学)計画

⑥サマリー

Large scale neutron source
High flux, but
limited machine time



**We need
both !!**

Small scale neutron source
Low flux, but
Taylor-made studies

- **HUNS:**
Hokkaido
University
Neutron
Source
- **45MeV Electron linac**

- **RANS:**
Riken
Accelerator-driven
Neutron
Source
- **7MeV, 700W proton Linac**

② High current, high duty RFQ + DTL

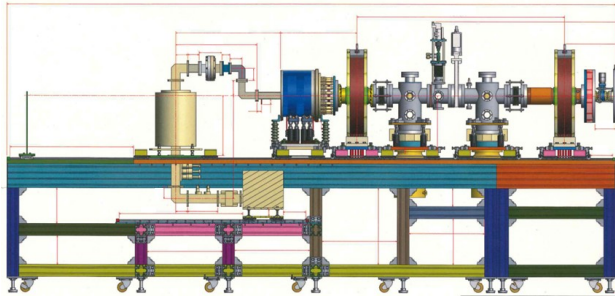

- ① ECR ion source
- High current
- Easy to maintenance

- ③ long pulse Klystron modulator

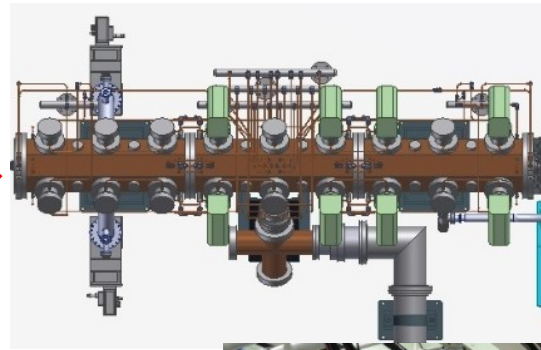

- ④ MBK For OIST-BNCT



- First and second compact BNCT (proton driver) construction
- ➔ Ibaraki BNCT, full commissioning will be very soon (POC machine)
- ➔ OIST-BNCT six years construction program has been just started
- The role is to establish the first mass production model
- Technologies for BNCT are common with front-end of the large scale machine
- BNCT linac can be applied as a compact neutron source for material/life science and industrial applications